



MV5C

Home Office Microphone

The Shure USB home office microphone, MV5C, user guide.
Version: 4.0 (2022-L)

Table of Contents

MV5C Home Office Microphone	3	Monitoring Options for the MV5C	6
General Description	3	Listening Through the Computer Output	6
Features	3	Listening Through the Headphone Output (Direct Monitoring)	6
Quick Setup	3	MV5 vs MV5C	7
Connections and Controls	3	Troubleshooting	7
Preset Modes	5	System Requirements and Compatibility	8
Placement	5	Specifications	8
Adjusting Microphone Level	5	Accessories	10
Adjusting Headphone Level	6	Furnished Accessories	10
Accessing the Control Panel	6	Certifications	10
		Information to the user	10

MV5C

Home Office Microphone

General Description

The Shure MV5C microphone connects directly to a computer over a USB connection. Ideal for conferencing applications, the MV5C features a preset speech mode for clear vocal reproduction.

Features

- **Convenient, Compact Design:** This sleek and durable microphone mounts on the included MV5C desktop stand or any stand with a 1/4" threaded adapter.
- **Plug and Play:** The MV5C automatically becomes the active audio input device when plugged into a computer. The audio output will remain the computer speakers or headphone output.
- **Preset Modes:** Minimize setup time with the preset DSP mode designed to automatically adjust your gain, equalization and compression for speech applications.

Quick Setup

1. **Connect the microphone to your computer. Use the appropriate cable (USB-A or USB-C).**

The center green status LED indicates a successful connection.

2. **Confirm that the MV5C is the selected audio device.**

Most computers automatically detect the MV5C and assign it as the primary audio device. If your computer settings default to another device, open the sound control panel and select MV5C.

***Note:** The first time you connect to the MV5C, audio playback will remain assigned to the previously selected output. This means the microphone will be enabled for audio input, but not output. Audio output will still come through your computer speaker or headphone output.*

3. **Hold the MODE button while plugging in the MV5C to enable the MV5C headphone output.**

The MV5C headphone output is not enabled to ensure that your audio playback is not interrupted. However, to enable the MV5C headphone output, hold the MODE button while you connect the MV5C. The headphone LED will turn green to indicate that the headphone output is active.

4. **Press the MODE button to toggle speech mode on and off.**

Speech mode is a gain, compression and EQ preset designed to optimize voice tone and clarity. The green speech icon LED indicates that speech mode is on.

5. **In your conferencing application, select the MV5C as the input source.**

See your software user guide for information on assigning input sources.

For more information about monitoring options, see the Monitoring Options for the MV5C section.

Connections and Controls

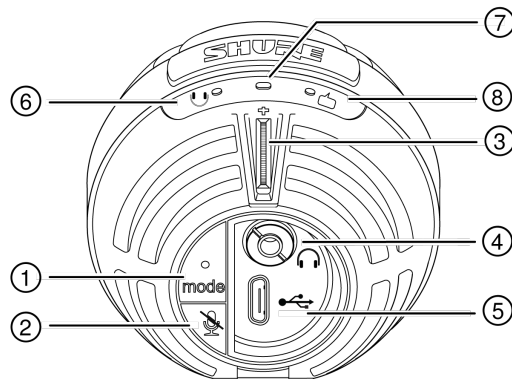

① Mode Selection Button

Press to turn speech mode on and off.

② Mute Button

Press to mute the microphone input. All MV5C LEDs will turn red when microphone is muted.

③ Headphone Volume Control

Adjusts the headphone volume when the MV5C headphone output is enabled.

④ Headphone Output

Plug in any headphones with a 3.5 mm (1/8 inch) connector.

⑤ Micro USB Port

Use the appropriate cable (USB-A or USB-C) to connect the MV5C to a computer.

⑥ Monitor Indicator (Headphone LED)

LED Behavior	Status
Green	Headphone output is enabled. Direct monitoring is on.
Red	Headphone output is enabled. Direct monitoring is off.
Off	Headphone output is disabled.

Note: Direct monitoring refers to listening to playback through the MV5C headphone output.

⑦ Status Indicator



LED Behavior	Status
Green	Active USB connection
Red (all 3 LEDs)	Muted

⑧ Speech Mode

The LED indicator illuminates when speech mode is selected.

Preset Modes

These selectable modes adjust settings for gain, equalization, and dynamics to bring out the best sound characteristics for your voice recording needs.

Mode	Application	Characteristics
 Speech <i>h</i>	Use for speech or vocals in conferencing applications	A mix of preset gain, compression and EQ processing that optimizes the sound of your voice for clarity. A de-esser reduces sibilance (the harsh sound that occurs when words with an "S" are spoken).
 Flat	Suited for any application	A completely unprocessed signal (no equalization or compression settings used). Adds flexibility when processing the audio after recording.

Placement

For conferencing applications, place the MV5C 12-18 inches (30-46 cm) away from your face and select speech mode. For best results, place the microphone just to the left or right of your keyboard with the circular Shure logo pointed towards your mouth. This properly orients the microphone for optimal sound pickup.

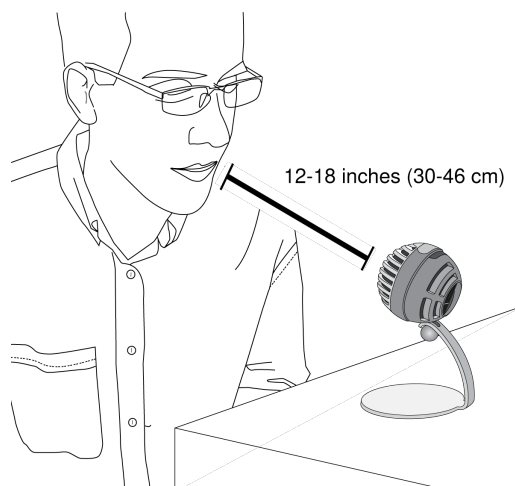

Adjusting Microphone Level

Microphone level (gain) typically does not need adjustment when using the microphone with a conferencing platform. However, if you hear distortion or the audio is too low, adjust the microphone level in the audio or sound control panel of your computer.

Keep the following in mind:

- Set the microphone level before adjusting headphone volume.
- The headphone volume does not affect the signal level sent to the computer.

Adjusting Headphone Level

Easily adjust the headphone monitoring level by using the MV5C thumbwheel by enabling the MV5C headphone output.

Accessing the Control Panel

Windows

1. Open the Settings window, select System > Sound.
2. Select **Shure MV5C** as your input device.
3. Adjust the gain by using the Levels slider.

Mac®

1. In System Preferences, select Sound.
2. Select the **Shure MV5C** device as your Input and Output source.
3. Use the Input volume slider to adjust the gain.

Monitoring Options for the MV5C

Listening Through the Computer Output

Connect the MV5C to your computer using the USB cable and listen through your computer's built-in speakers or headphone output. If you are listening to computer audio playback, the headphone LED on the MV5C will be off because the headphone output is off.

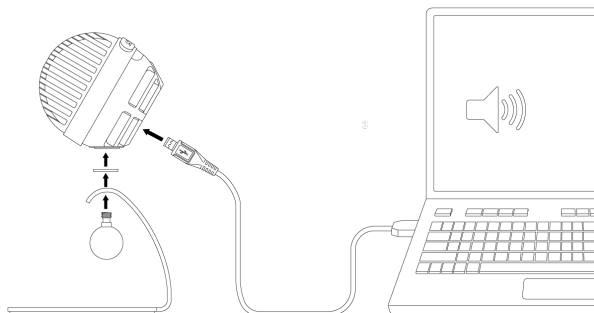

Listening Through the Headphone Output (Direct Monitoring)

When the MV5C headphone output is enabled, the headphone jack provides an equal blend of the direct microphone signal (your voice) and audio playback from the computer (your conference). This allows you to conveniently adjust the headphone volume for both with one control, the MV5C thumbwheel.

Press and hold the MV5C Mode button while connecting to your computer using the USB cable. Now connect headphones to the MV5C headphone output to hear the audio playback. If you are listening to audio from the headphone output, the headphone LED on the MV5C will be green.

To turn off headphone audio, press and hold the MV5C mode button. The headphone LED will turn amber.

Tip: When first connecting the microphone to your computer, make sure to raise the volume level in the sound control panel of the computer for a strong audio signal. Then adjust headphone level for comfortable monitoring.

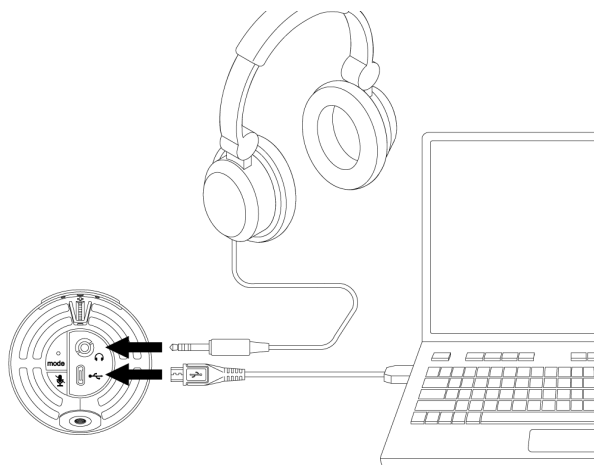

MV5 vs MV5C

Troubleshooting

Issue	Solution
The middle LED does not illuminate	Make sure that the MV5C is fully plugged in.
Audio is too low	Check the computer sound control panel settings. When first connecting the MV5C to your computer, make sure to raise the computer volume level.
Audio sounds bad	Check the sound control panel of the computer to ensure that the MV5C is fully plugged in and selected as your audio device.
Audio is distorted	Use the audio meter to ensure that volume peaks are within the target range. If level is reaching the top of the input meter, turn the gain down.
Device not working with USB hub.	The MV5C requires 250 mA per port. Check USB hub documentation for current/port specification.
General troubleshooting	Quit and re-start your app. Reboot the computer.

Note: Contact Shure Service and Repair if you continue to experience any issues.

System Requirements and Compatibility

Windows	Windows 7 and higher Minimum RAM = 64 MB USB 2.0
Macintosh	OS X Lion 10.7 and higher Minimum RAM = 64 MB USB 2.0

Specifications

DSP Modes (Presets)

Speech/Flat

Cartridge Type

Electret Condenser (16 mm)

Polar Pattern

Unidirectional (Cardioid)

Bit Depth

16-bit/24-bit

Sampling Rate

48 kHz

Frequency Response

20 Hz to 20,000 Hz

Adjustable Gain Range

0 to +36 dB

Sensitivity

-40 dBFS/Pa at 1 kHz[1] [2]

Maximum SPL

130 dB SPL [2]

Headphone Output

3.5 mm (1/8")

Power Requirements

Powered through USB connector

Mute Switch Attenuation

Yes

Mounting Stand

Included

Stand Adapter

1/4 inch 20 thread (standard tri-pod mount)

Housing

PC/ABS

Net Weight

Without Mounting Stand	0.09 kg (3.17oz.)
With Mounting Stand	0.16 kg (5.64oz.)

Dimensions

66 x 67 x 65 mm H x W x D

Dimensions with Stand

89 x 142 x 97 mm H x W x D

Cable

1 m USB-A cable/1 m USB-C cable

[1] 1 Pa=94 dB SPL

[2]At Minimum Gain, Flat Mode

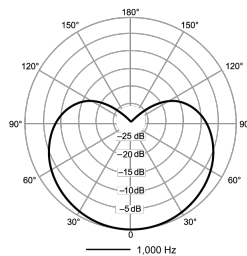

Polar Pattern

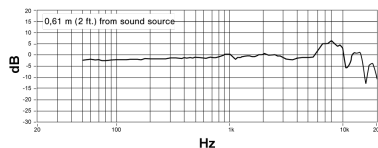

Frequency Response

Accessories

Furnished Accessories

MV5 Desktop Stand	AMV5-DS
1 m USB cable	AMV-USB
1 m USB-C cable	95C38076

Certifications

Information to the user

This equipment has been tested and found to comply with the limits for a Class B digital device, pursuant to part 15 of the FCC Rules. This equipment generates, uses, and can radiate radio frequency energy and, if not installed and used in accordance with the manufacturer's instruction manual, may cause interference with radio and television reception.

Notice: The FCC regulations provide that changes or modifications not expressly approved by Shure Incorporated could void your authority to operate this equipment.

These limits are designed to provide reasonable protection against harmful interference in a residential installation. This equipment generates, uses, and can radiate radio frequency energy and, if not installed and used in accordance with the instructions, may cause harmful interference to radio communications. However, there is no guarantee that interference will not occur in a particular installation. If this equipment does cause harmful interference to radio or television reception, which can be determined by turning the equipment off and on, the user is encouraged to try to correct the interference by one or more of the following measures:

- Reorient or relocate the receiving antenna.
- Increase the separation between the equipment and the receiver.
- Connect the equipment to an outlet on a circuit different from that to which the receiver is connected.
- Consult the dealer or an experienced radio/TV technician for help.

This device complies with part 15 of the FCC Rules. Operation is subject to the following two conditions:

1. This device may not cause harmful interference.
2. This device must accept any interference received, including interference that may cause undesired operation.

Industry Canada ICES-003 Compliance Label: CAN ICES-3 (B)/NMB-3(B)

Note: Testing is based on the use of supplied and recommended cable types. The use of other than shielded (screened) cable types may degrade EMC performance.

CE Notice:

Hereby, Shure Incorporated declares that this product with CE Marking has been determined to be in compliance with European Union requirements. The full text of the EU declaration of conformity is available at the following site: <https://www.shure.com/en-EU/support/declarations-of-conformity>.

Authorized European Importer / Representative:

Shure Europe GmbH
 Department: Global Compliance
 Jakob-Dieffenbacher-Str. 12
 75031 Eppingen, Germany
 Phone: +49-7262-92 49 0
 Fax: +49-7262-92 49 11 4
 Email: EMEAsupport@shure.de

This product meets the Essential Requirements of all relevant European directives and is eligible for CE marking.



Use of the Made for Apple badge means that an accessory has been designed to connect specifically to the Apple product(s) identified in the badge and has been certified by the developer to meet Apple performance standards. Apple is not responsible for the operation of this device or its compliance with safety and regulatory standards.

Apple, iPad, iPhone, iPod and Lightning are trademarks of Apple Inc., registered in the U.S. and other countries. tvOS is a trademark of Apple Inc. The trademark "iPhone" is used in Japan with a license from Aiphone K.K.

Mac and Lightning® are registered trademarks of Apple Inc.

