

# iD44

20in | 24out  
Audio Interface

## Manual

AUDIANT

# Welcome to your new Audient iD44 Audio Interface

To help get you started please visit [audient.com/products/iD44](https://audient.com/products/iD44) to download the latest software and firmware.

The 12VDC power supply comes with interchangeable UK, EU, US and Australian socket adapters and will work across a broad range of line voltages making iD44 globally portable.

## Inside the box:

- iD44
- 12VDC PSU with regional adapters
- USB Type C Cable
- Quick Start Guide



## Features include:

- 4 x Class - A Audient Console Mic Preamplifiers
- Class Leading AD/DA Converters
- 2 x ADAT Inputs & Outputs for Digital Expansion
- 2 x Discrete JFET Instrument Inputs
- 2 x Fully Balanced Inserts
- 2 x Independent Class-AB Headphone output channels with options for 1/4 inch and 3.5mm headphone jacks
- Main and Alt Speaker Outputs
- Audio Loop-back
- ScrollControl
- 3 x User Defined Function Keys
- Dedicated Talkback, Dim and Cut Controls
- Low Latency DSP Mixer
- Word Clock Output
- USB 2.0 Compliant
- 24bit/96khz
- All-Metal Enclosure
- Standalone Mode
- Free Software & Plugins

# Contents

<b>iD44 Overview</b>	4	<b>DAW Setups:</b>	45
<b>Safety Information</b>	5	Pro Tools Setup	46
<b>Declaration of Conformities</b>	7	Logic Pro Setup	47
<b>Installation:</b>	8	Cubase/Nuendo Setup	49
Mac Installation	9	Ableton Setup	51
Windows Installation	12	<b>Troubleshooting &amp; FAQ</b>	52
iD App & Firmware Update	14	<b>Technical Specifications</b>	55
<b>Hardware Features:</b>	15	<b>Dimensions</b>	56
Microphone & Line Input	16	<b>Warranty</b>	57
Instrument Input	17	<b>Service &amp; Contact</b>	58
Send and Returns	17	<b>Glossary</b>	59
Digital Inputs and Outputs	19		
Loudspeaker Outputs	24		
Headphone Outputs	24		
Monitor Control	25		
Metering	27		
Kensington Lock	27		
<b>Software Features:</b>	28		
Input Channel Types	29		
Channel Features	31		
Mastering Section Features	32		
System Panel Features	35		
The Routing Matrix	37		
Setting Up Talkback	38		
Save & Loading Presets	39		
Menu & Task Bar Icon	40		
Standalone Mode	41		
Firmware Update	41		
Audio Loop-Back	42		
Keyboard Shortcuts	44		

# iD44 Overview

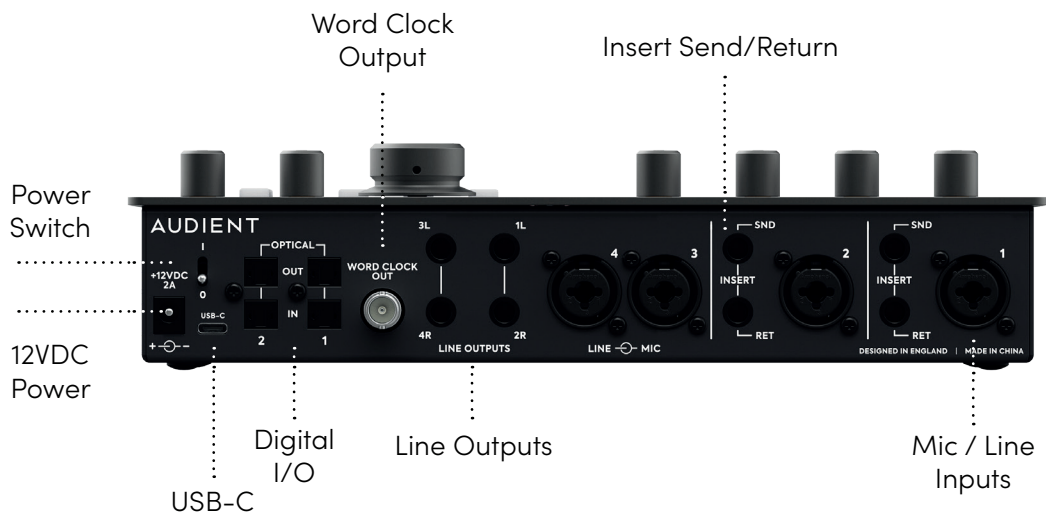
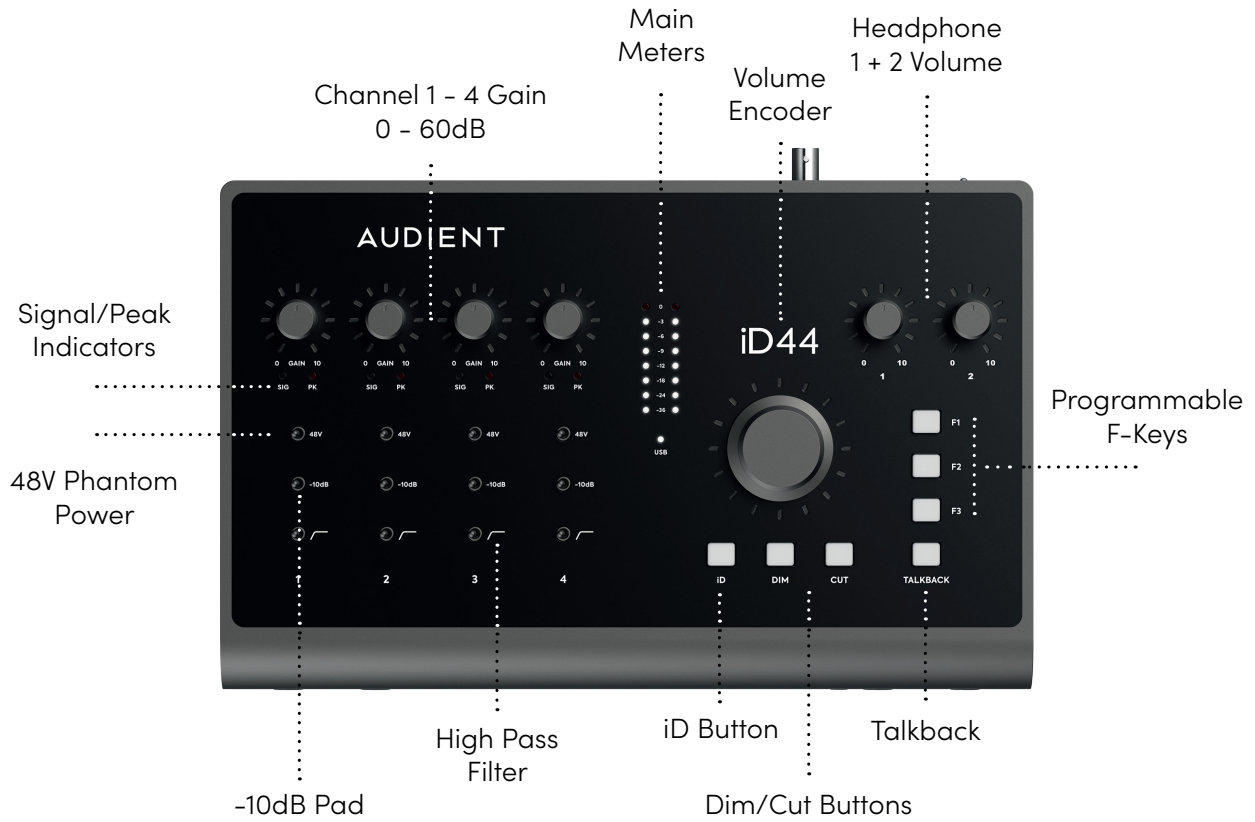

# Safety Information

## Important Safety Instructions

Please read all of these instructions and save them for later reference before connecting the DC power adapter to the mains and powering up iD44.

To prevent electrical shock and fire hazard follow all instructions on the 12VDC power supply. iD44 itself does not operate with any high voltage mains supply inside the unit but appropriate safety measures should still be adhered to regarding the AC/DC supply.

Please ensure you only use the supplied iD44 power supply. We cannot recommend the usage of third party power supplies. In the event of a power supply failure do not open the 12VDC supply. If required, please contact Audient support so that a suitable replacement can be sourced.

[support.audient.com](http://support.audient.com)

iD44 utilises an external switch-mode power supply that is very quiet and rated at 2A. This switch-mode design will accept any A.C line voltage from 90v to 264v @ 47-63Hz. Therefore the unit will work anywhere in the world but please ensure your A.C mains line voltage is within this specification.

Consult a qualified technician if you suspect difficulties. Do not attempt to tamper with the power supply or mains voltages - **HAZARDOUS TO HEALTH**. Ensure that the appropriate international pin adapter is fitted to the power supply before insertion into the mains socket.

### **WARNING!**

To reduce risk of fire or electrical shock, **DO NOT** expose this apparatus to rain or moisture.

No user serviceable parts inside.  
Please refer servicing to qualified service personnel.

# Safety Information

## Important Safety Instructions

1. Read these instructions
2. Keep these instructions
3. Heed all warnings
4. Follow all instructions
5. Do not use this equipment near water
6. Clean only with dry cloth
7. Do not install near any heat sources such as radiators, heat registers, stoves, or other equipment (including amplifiers) that produce heat
8. Do not defeat the safety purpose of the polarized or grounding-type plug. A polarized plug has two blades with one wider than the other. A grounding type plug has two blades and a third grounding prong. The wide blade or the third prong are provided for your safety. If the provided plug does not fit into your outlet, consult an electrician for replacement of the obsolete outlet
9. Protect power cords from being walked on or pinched particularly at plugs, convenience receptacles, and the point where they exit from the equipment
10. Only use attachments/accessories specified by the manufacturer
11. Unplug this equipment during lightning storms or when unused for long periods of time
12. Refer all servicing to qualified service personnel. Servicing is required when the equipment has been damaged in any way, such as power supply cord or plug is damaged, liquid has been spilled or objects have fallen into the equipment, the equipment has been exposed to rain or moisture, does not operate normally, or has been dropped
13. For products that are a mains powered device: The equipment shall not be exposed to dripping or splashing and no objects filled with liquids (such as vases) shall be placed on the equipment

# Declaration of Conformities

## FCC Part 15B

This apparatus has been tested and found to comply with the limits of a class-A digital device, pursuant to Part 15B of the FCC Rules. These limits are designed to provide reasonable protection against harmful interference in a residential installation. This equipment generates, uses and can radiate radio frequency energy and, if not installed and used in accordance with the instructions, may cause harmful interference to radio communications. If this equipment does cause harmful interference to radio or television reception, which can be determined by turning the equipment off and on, the user is encouraged to try to correct the interference by one or more of the following measures:

1. Re-orient or relocate the receiving antenna
2. Increase the separation between the equipment and receiver
3. Connect the equipment into an outlet on a different circuit from that to which the receiver is connected
4. Consult the dealer or an experienced radio/TV technician for help



We, Audient Ltd, Aspect House, Herriard, Hampshire, RG25 2PN, UK, 01256 381944, declare under our sole responsibility that the product iD44 complies with Part 15 of FCC Rules.

Operation is subject to the following two conditions:

1. This device may not cause harmful interference,
2. This device must accept any interference received, including interference that may cause undesired operation



We, Audient Ltd, declare that the product, the iD44, to which this declaration relates, is in material conformity with the appropriate CE standards and directives for an audio product designed for consumer use.



We, Audient Ltd, declare that the product, the iD44, to which this declaration relates, is in material conformity with the appropriate UKCA standards and directives for an audio product designed for consumer use.



Audient Ltd has conformed where applicable, to the European Union's Directive EN 63000:2018 on Restrictions of Hazardous Substances (RoHS) as well as the following sections of California law which refer to RoHS, namely sections 25214.10, 25214.10.2, and 58012, Health and Safety Code; Section 42475.2, Public Resources

# Installation



# Mac Installation

## System Requirements

macOS 10.11.6 (El Capitan) or Later  
Mac Intel CPU or Apple Silicon  
1GB RAM Minimum

## 1. Download the latest iD Software

Head to our website for the latest version of our iD Mixer:

[audient.com/products/id44](https://audient.com/products/id44)

Open the downloaded .dmg file. Now, drag the downloaded app into your application folder to install it.

## 2. Connect iD44

Using the USB cable provided, connect iD44 to your computer's USB port.



USB - C

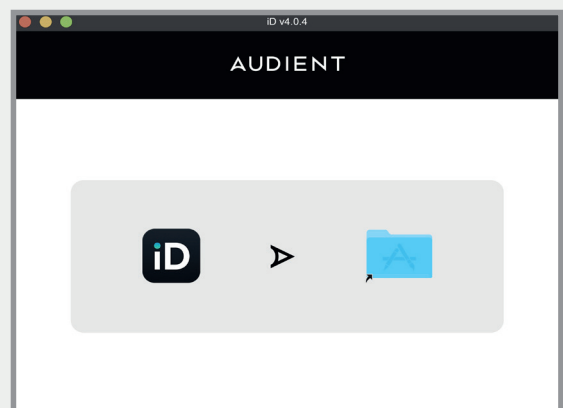

# Mac Installation

## 3. Status LED

Once connected to your computer and powered on, the green status LED on iD44 will illuminate.

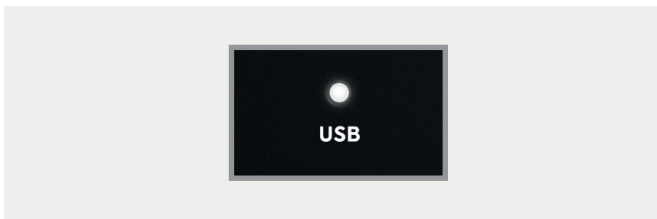

If at any time the status LED turns off during normal operation please check all connections and if further problems develop please contact Audient support.

## 4. Double Checking Connectivity

To ensure iD44 has been detected by your computer and correct clocking sources are set-up, navigate to:

**Macintosh HD > Applications > System Preferences**

Check that iD44 is set as your audio device. It's recommended to disable system sounds.

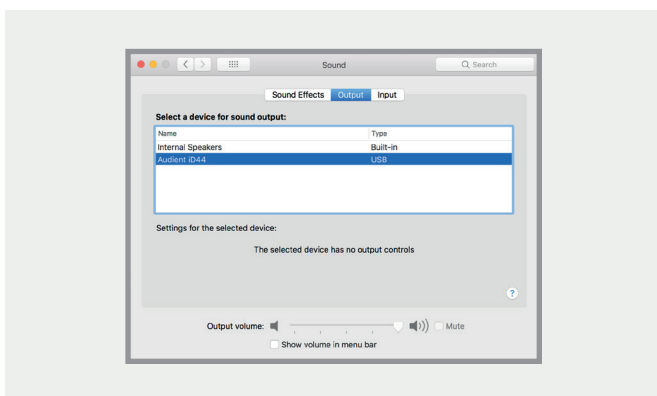

It's also worth checking Audio MIDI Setup (found in **Mac HD > Applications > Utilities**).

**Window > Show Audio Window**

Here you should see iD44 report with 20 inputs and 24 outputs. The clock source is configured in the iD app. See **page 23** for more details.

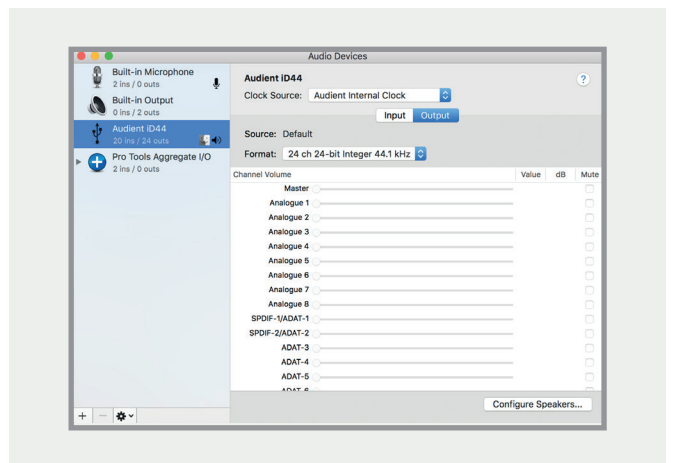

# Mac Installation

## Menu/Task Bar Icons

On MacOS, the iD icon appears in the menu bar in the top right hand corner of the screen. This gives you quick access to various functions of the iD44.

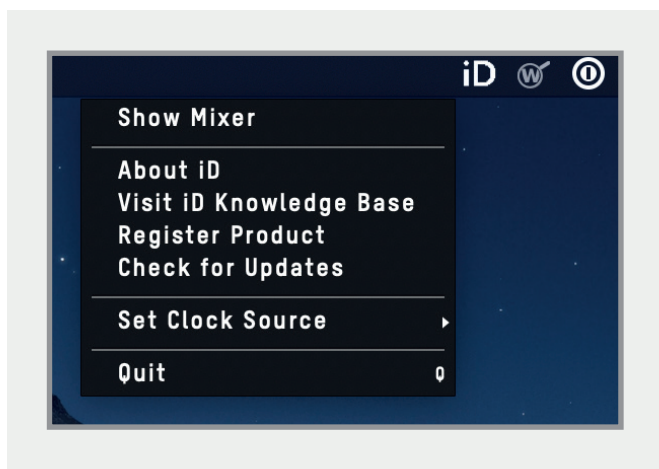

### Show Mixer

If the mixer window has been hidden, this will bring it back to the forefront.

### Quit

Fully closes the iD Software Mixer application.

### About iD

Displays information regarding the current version of the iD Software Mixer application and firmware.

### Visit iD Knowledge Base

Opens a browser windows for the Audient Helpdesk with helpful articles and FAQs.

### Check for Updates

The iD app will check with the Audient update server for any available firmware updates for iD44.

## Top Tip

Right click on the iD icon in the Dock and select Keep in Dock to have quick access to the iD mixer app at all times.

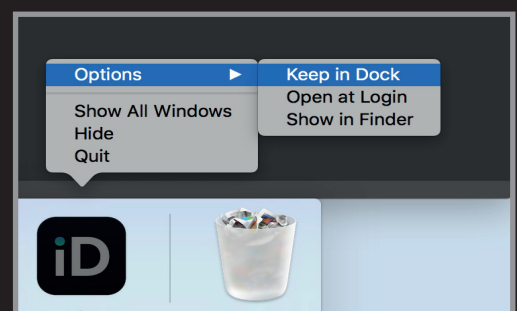

# Windows Installation

## Windows System Requirements:

Windows 8 or later (32 or 64 bit)

Intel Core 2 @1.6Ghz, or AMD equivalent 1GB

RAM Minimum

## 1. Download the iD44 Software

Head to our website for the latest version of our iD Windows Installer:

[audient.com/products/iD44](http://audient.com/products/iD44)

## 2. Connect iD44

Using the USB cable provided, connect iD44 to your computer's USB port and connect the iD44's power supply.

## 3. Run iD Mixer Setup

Double click on the installer to run the iD mixer setup and follow the on-screen instructions.

## 4. Reboot PC

Reboot your PC to make sure that all the drivers have been applied.

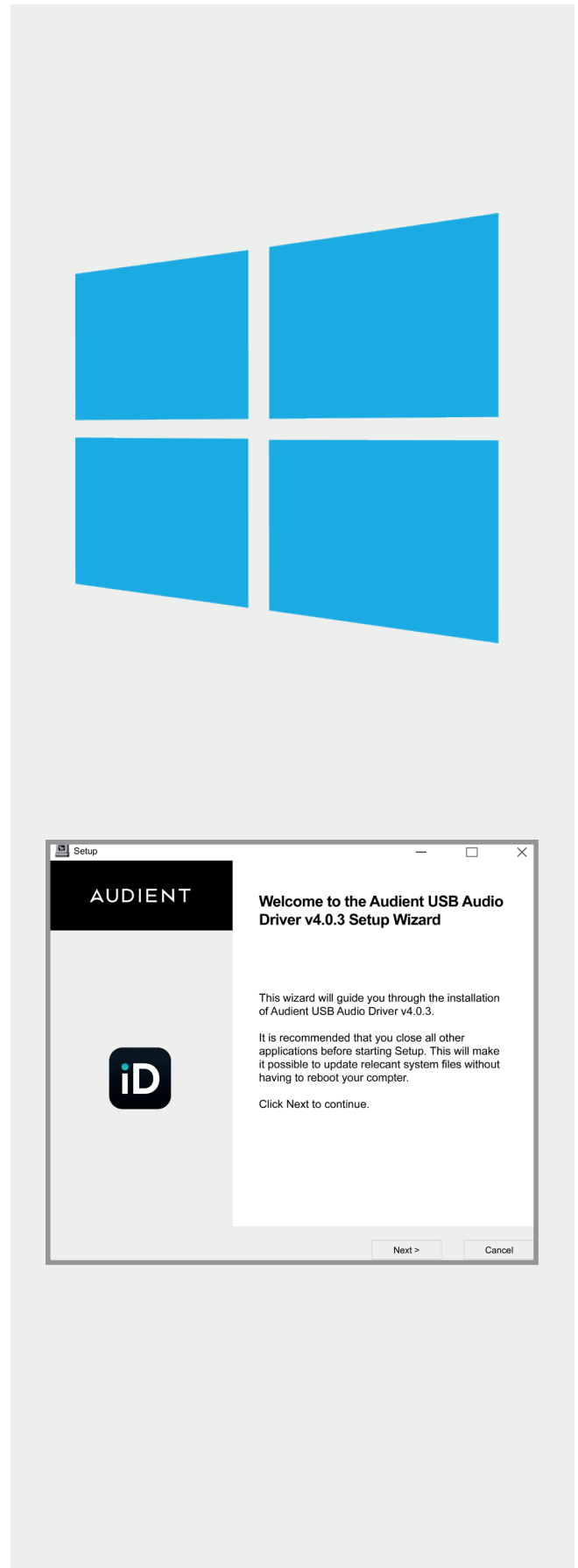

## 4. Check Connectivity

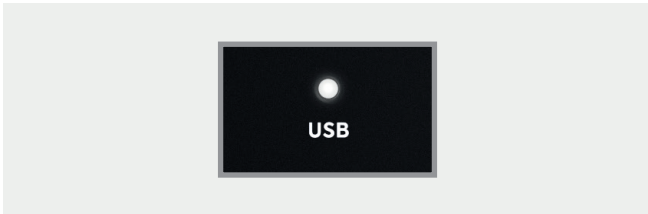

The USB status LED will illuminate as soon as iD44 has achieved stable communication and should remain solidly lit during operation of the unit until power down.

To double check the connection, go to PC sound settings by following:

### PC Settings > Control Panel > Hardware and Sound > Sound

Here you can see whether iD44 is visible to the PC and you can make it the computers default sound device by pressing 'Set Default'.

### iD Icon

Once installed, the iD icon can be found in the Windows system tray (it may be in the hidden icons area):

- Double-click to open the iD44 mixer window when iD44 is connected.
- Right-click to quit or change sample rate and buffer size.

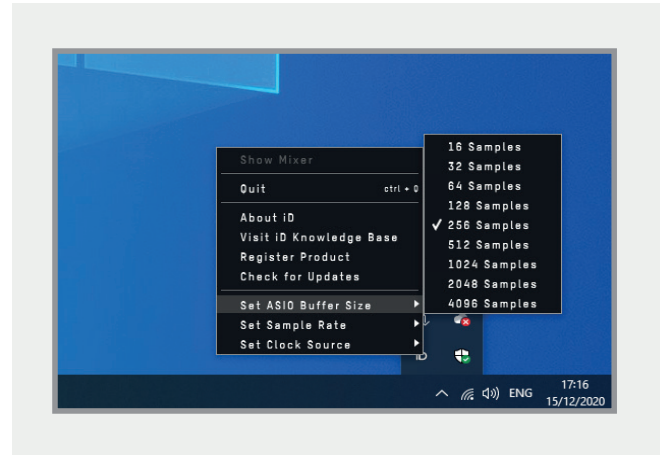

For mixing, a buffer size of 256 should be perfect. For tracking, experiment with lower buffer size values.

Various factors including how powerful your computer is, and how processor hungry your project is, will affect how low you can get the buffer size settings before you get audio instability.

More information on optimisation can be found on our support site.

# iD App & Firmware Update

## Launch the iD Mixer Application

Launch the iD mixer application by finding it in the following folder:

### Mac OS

Macintosh HD > Applications > iD

### Windows

Start > All Programs > Audient > iD

For more information on the mixer application feature set, please refer to the Software Features section of this manual.

On Windows, the app will launch when the device is connected.



## Check for Firmware Updates

If your computer is connected to the internet, the iD app will check for firmware updates whenever a unit is connected. If there is a firmware update available then the iD app will notify you.

Once the firmware update is complete, you can continue using iD44 as normal.

## Firmware Update

When there is a firmware update, you can select 'From audient.com' to download the latest version automatically (or select 'From file' to install a local firmware file).

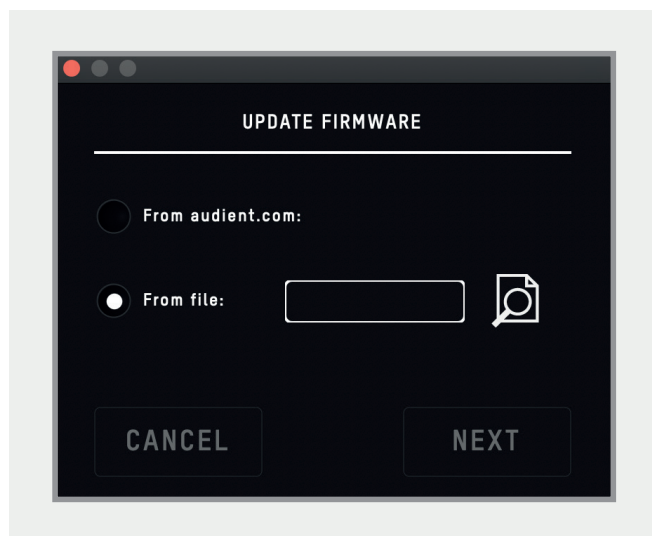

The latest version number will be retrieved from our servers and will be displayed. Press next to continue with the firmware update. Press 'update' to install it. Once complete reboot iD44 using the power switch to apply it manually.

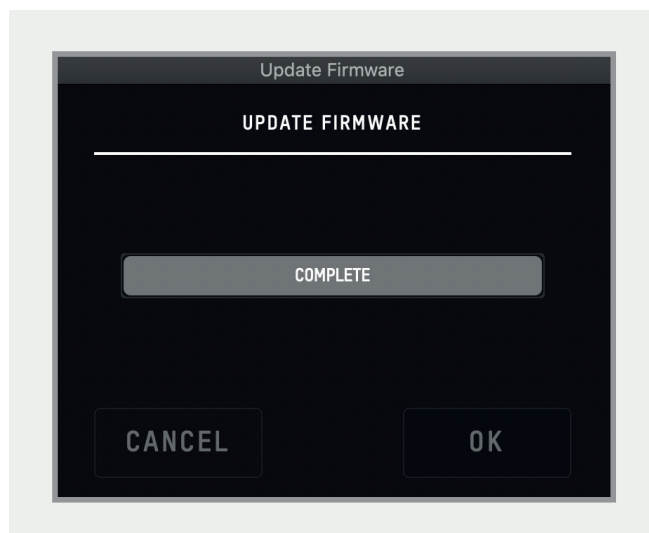

# Hardware Features

## Microphone Preamplifiers & Line Inputs

iD44 features four classic Audient microphone preamplifiers. These preamps are based on designs from Audient's classic consoles and are the same that are used across our entire product range.

The design features discrete Class-A circuitry providing exceedingly low distortion and noise performance. From a sonic point of view, iD44 is fast, open and detailed.

Amphenol™ XLR/TRS Jack combi-connectors provide microphone and line inputs. The line inputs are padded through the microphone preamplifiers.

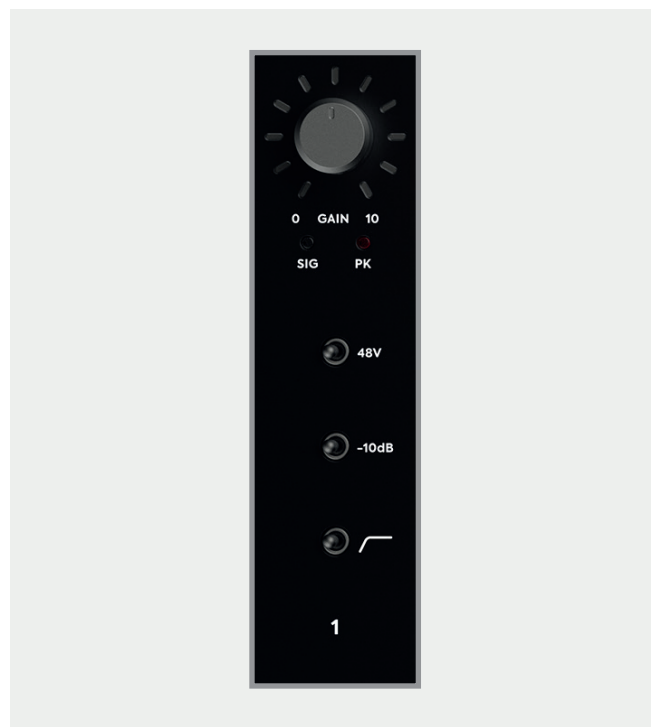

### The four microphone preamplifiers feature:

- 58 dB of clean gain
- 48V ( $\pm 4V$ ) phantom power rated at 14mA/channel
- $>2.8k\Omega$  input impedance which provides a punchy tone from any microphone transducer type
- Signal and Clip Indicators
- -10dB Pad
- 100Hz High Pass Filter to remove unwanted rumble

Channels 1 and 2 also include an Insert Send and Return allowing for the use of outboard equipment while tracking.



## Instrument Input

iD44 employs 2 discrete Class-A JFET instrument (D.I) inputs on channels one and two which are easily accessible on the front of the unit.

The JFET circuitry adds a tiny bit of colour and warmth to the signal, making it sound great on guitars and basses.

Plugging in a TS (tip-sleeve unbalanced) jack will override the mic signal for that channel and turn it into a fully fledged, fantastic sounding instrument input with access to the Pad and High Pass Filters.



## Balanced Inserts & Returns

On Channels 1 and 2, the iD44 features a dedicated insert allowing you to connect outboard gear to your recording chain; Just like the work flow you would find on an Audient console!

The two channels feature an impedance balanced send and an electronically balanced return, all before the AD converters.

Insert your favourite EQ and compressor into the insert and with the super clean audient pre-amps, you can build vocal chains that will rival the best out there!

## Insert Normaling

The Insert send and return jacks are half normalled meaning you don't need to patch the two together when not in use. The internal signal chain is only broken when a jack is plugged into the return. Plugging a jack into the Insert send will split the signal which can be useful for parallel processing.

# Class A Mic Preamplifier, Inserts, A/D converters and Optical Input Block Diagram

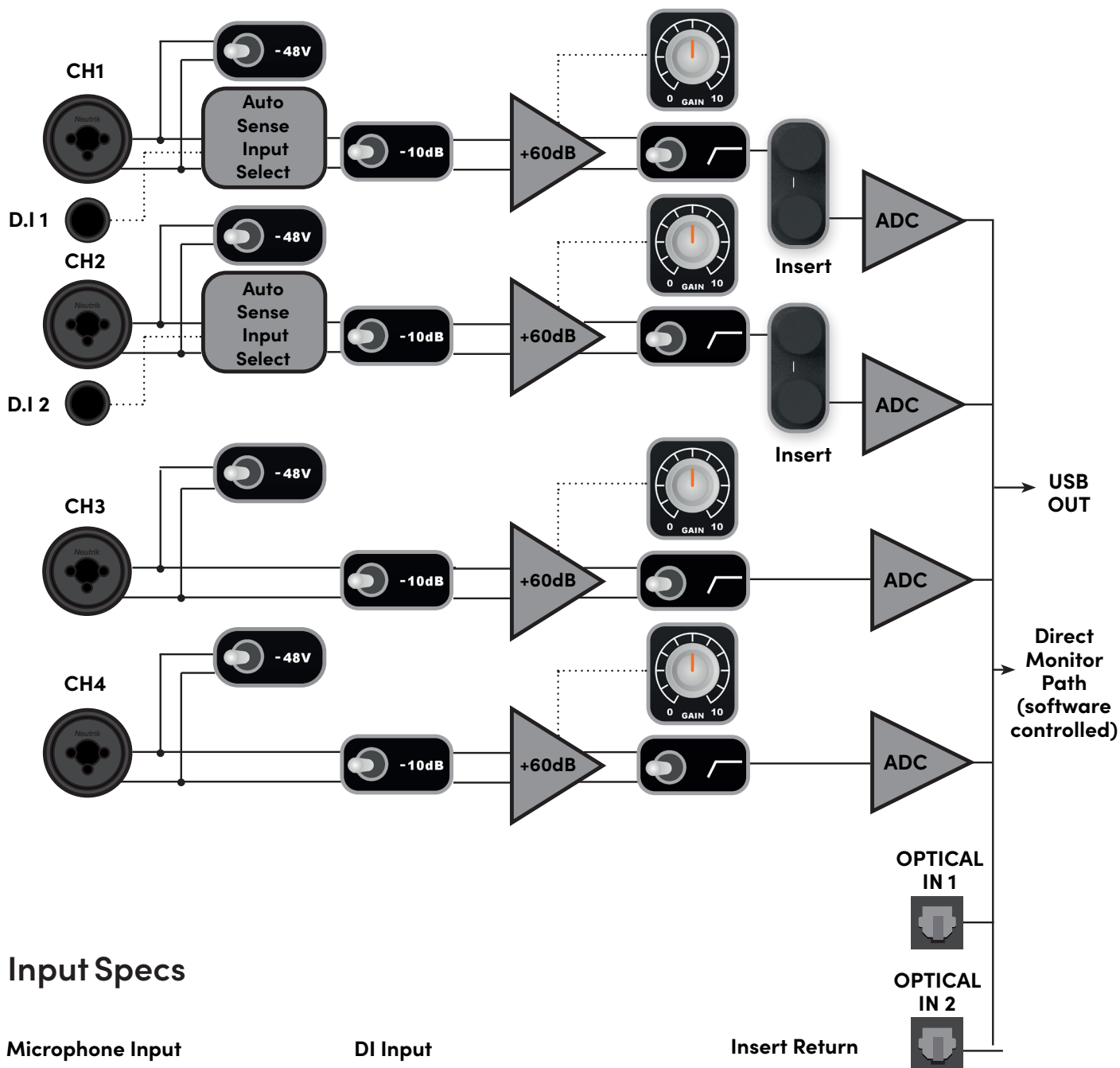

## Input Specs

### Microphone Input

XLR Combi Female  
 Pin 1: Chassis Ground Pin  
 Pin 2: Hot (+ve)  
 Pin 3: Cold (-ve)  
 Input Impedance: >2.8k ohm  
 Maximum Input Level: +18 dBu

### Line Input

1/4" TRS Combi Jack  
 Tip: Hot (+ve)  
 Ring: Cold (-ve)  
 Sleeve: Chassis Ground  
 Input Impedance: >8k ohm  
 Maximum Input Level: +28 dBu

### DI Input

1/4" TS Jack  
 Tip: Hot (+ve)  
 Sleeve: Ground  
 Input Impedance: >1Meg ohm

### Insert Sends

1/4" TRS Jack  
 Tip: Hot (+ve)  
 Ring: Cold (-ve)  
 Sleeve: Chassis Ground  
 Output Impedance: >100 ohm  
 Maximum Output Level: +22 dBu

### Insert Return

1/4" TRS Jack  
 Tip: Hot (+ve)  
 Ring: Cold (-ve)  
 Sleeve: Chassis Ground  
 Input Impedance: >10k ohm  
 Maximum Input Level: +18 dBu  
 Digital Reference: 0dBFS = +18dBu

### Optical Inputs

TOSLink Optical Connector  
 ADAT: 8 channels @ 48kHz  
 ADAT SMUX: 4 channels @ 96kHz  
 S/PDIF: 2 Channels @ All sample rates

## Patching Inserts

To incorporate your favourite processing before conversion, simply patch the iD44 insert send into the first piece of gear in your processing chain. Then take the output of the last device in the chain and patch this into the iD44 insert return.

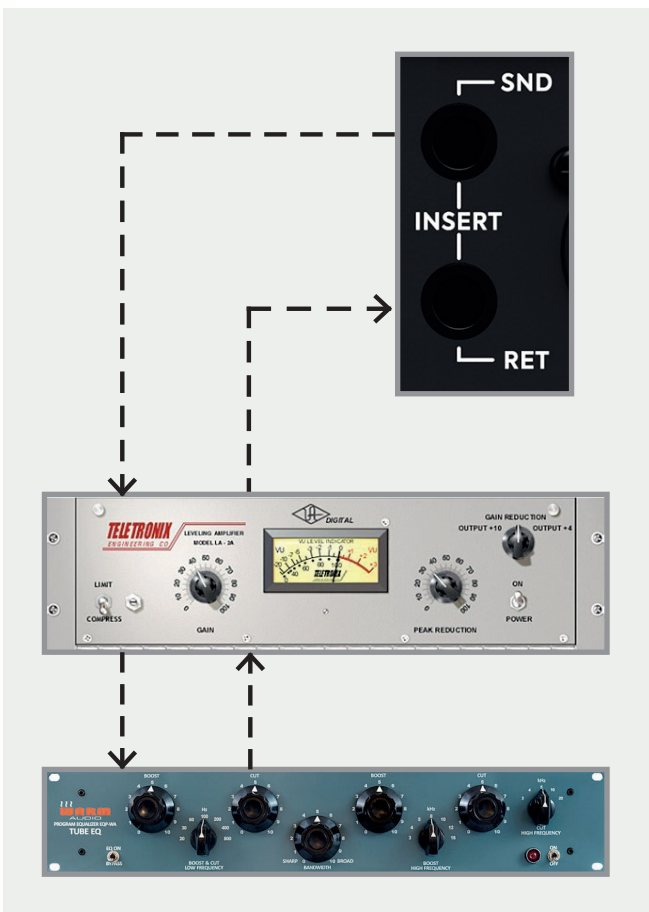

## Direct Access to ADC

The Insert return connection on the iD44 is a electronically balanced input stage that directly drives the analogue to digital converter for that channel.

As such, this is a great place to input signals directly to the ADC, bypassing the preamplifiers and minimising any colouration of the signal.

This makes it useful to patch in external microphone preamplifiers without adding additional colouration or noise. It is also handy for using the iD44's outputs to drive external effects before returning them into your DAW using the insert returns.

Please note; the digital calibration level of the iD44's converters is 0dBFS = +18dBu.

## Digital Inputs and Outputs

iD44 features two optical inputs and two optical outputs. These can be set to operate using optical stereo S/PDIF or 8-channel ADAT using the iD mixer application. All i/o will operate at up to 96kHz, with ADAT dropping to 4 channels at sample rates of 88.2kHz or higher.



Running in S/PDIF mode, the optical i/o provides the option to integrate external digital outboard, allowing up to 4 channels of audio in and out of the iD44 at sample rates up to 96KHz.

Running in ADAT mode, the optical i/o provides a great way to expand to 20 inputs for recording via external mic preamps such as the Audient ASP800.

The ADAT outputs could also be connected to headphone distribution systems such as a Hearback™ System or to an 8-channel DAC for summing purposes

When using 88.2kHz and 96kHz as a sample rate, you only have access to 8 channels of digital input and 8 channels of digital output (due to the ADAT protocol).

More information on how the iD mixer is used to route to the optical outputs can be found under The Routing Matrix section of this manual.

## Word Clock Output

The iD44 also includes a BNC Word Clock output which allows you to clock multiple digital devices to the iD44's master clock and keep everything in sync.

The Word Clock output will send a clock signal at the same sample rate (44.1, 48, 88.2 or 96kHz) that the iD44 is operating at. This will occur regardless of whether the iD44 is being clocked internally or externally.

## Clocking Configurations

When connecting external digital devices to the iD44, it's important to ensure that all devices are synchronised.

To ensure this, one device in the setup must be set as the master clock. The other devices will then use the master clock's signal to stay in sync. There can only ever be one master clock present in a chain.

The master clock signal can be sent either via an Optical cable embedded into the digital signal data, or through a BNC clock line cable. Please bear in mind that the clock will only travel in one direction through these connections, from a device's output to a device's input.

## Choosing a Master Clock

In a digital setup, there can be a number of options when determining which device should be your master clock. Quite often the best device to set as the master is the one that is connected to the computer (where possible) such as an audio interface. This way, when you open a project in a DAW, the audio interface should change to match the project sample rate, and therefore change the sample rate of all the slave devices. However this depends on the devices being used.

## iD44 as the Master Clock

With the iD44 set as the Master Clock the other devices in the chain can be clocked by either the Optical Outputs or the BNC word clock output.

When clocking just one device, clocking via the optical port would be the simplest option, simply connect the Toslink cable up to the iD44's optical output and to the other digital device's input.

Then set the other device to Slave off the iD44's clock.

If you are using multiple devices then it is recommended to use the BNC word clock output and then use T-connectors to daisy chain the devices together. It is important to note that the final device in the chain should have its BNC connector terminated with 75 Ohms to stop reflections of the clock signal. This should be a switchable option on most devices.

## iD44 with Single BNC Connection

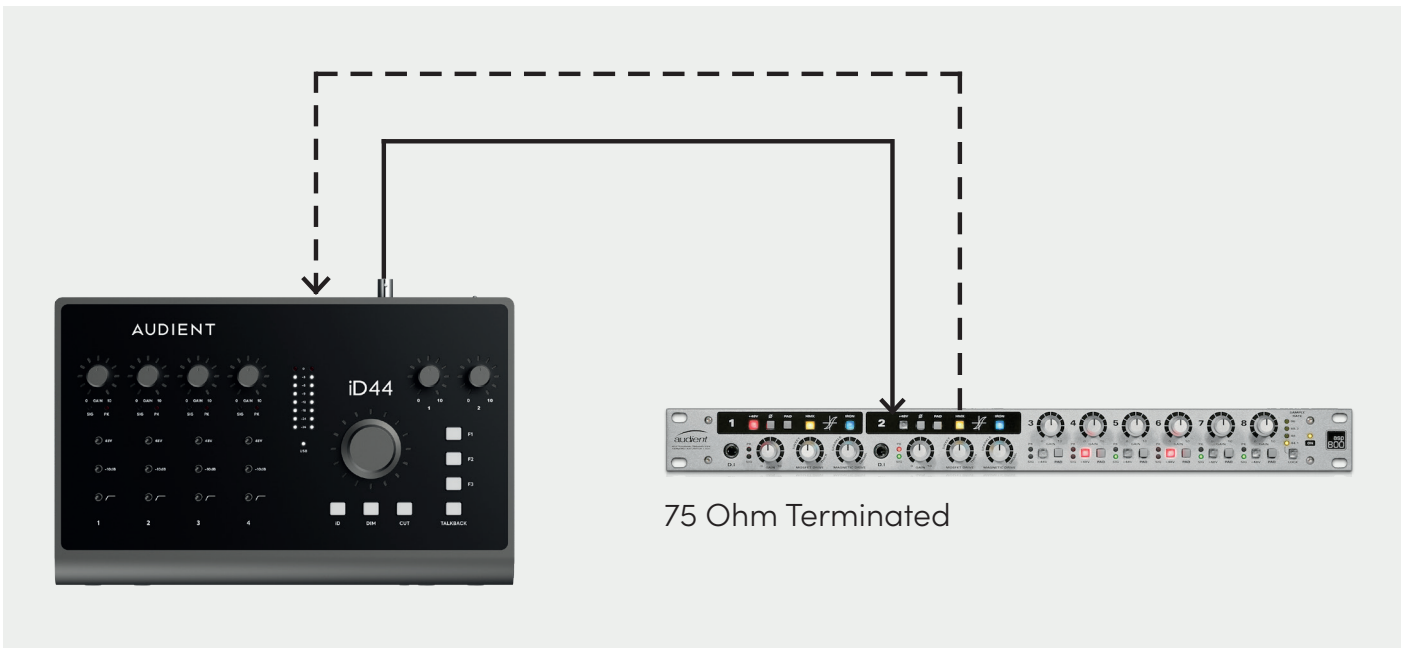

## iD44 with Daisychained BNC connection

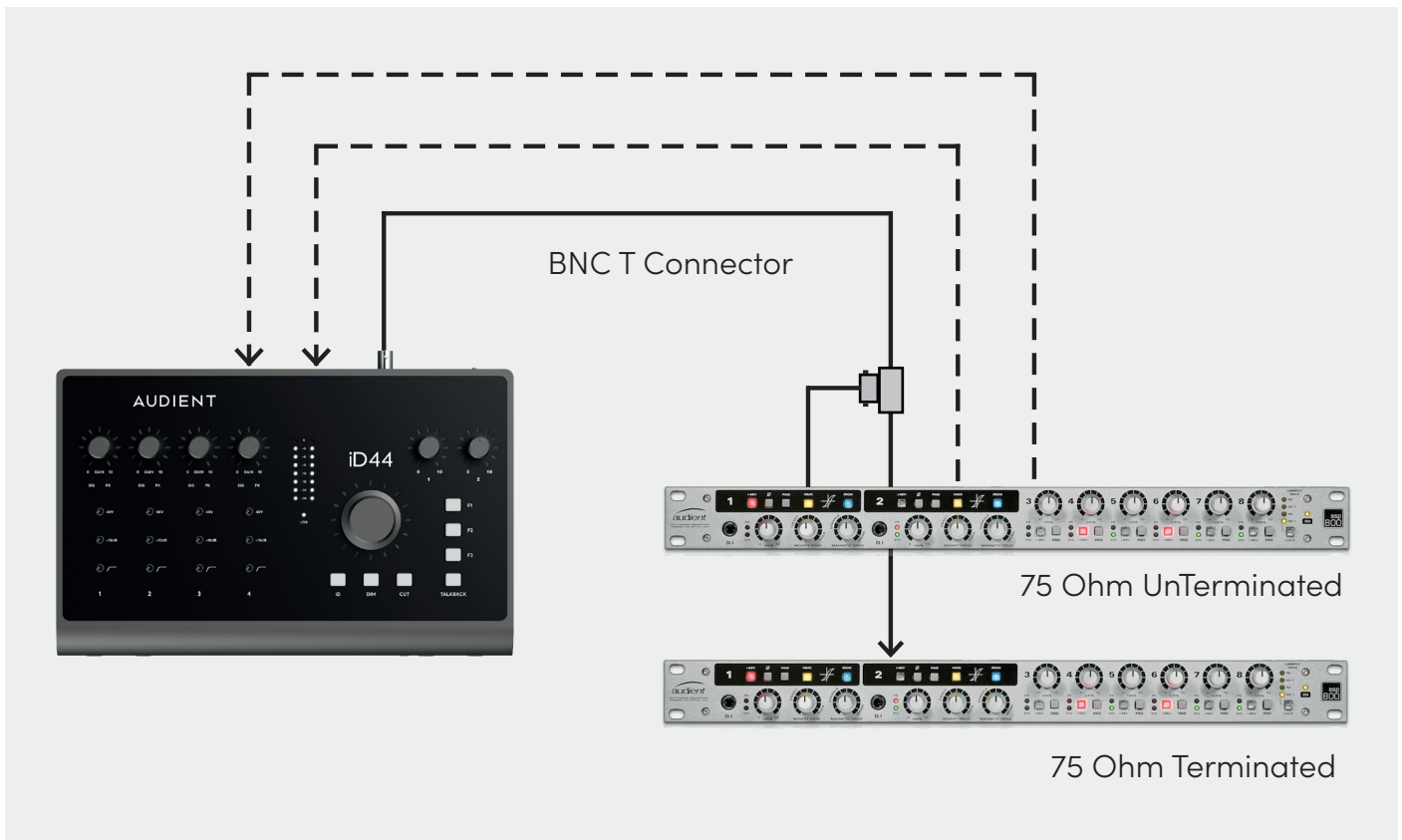

--- → Optical TOSlink Cable

————→ BNC Word Clock Cable

## iD44 as the Slave

The iD44 can also act as the slave to an external master clock via its optical inputs. The BNC connector is an output only.

In this case, you would simply connect the optical output of a device to the iD44's optical input. Then, in the iD Software Mixer, select the optical input you wish to be used as the clock source. You would also need to set the inputs to either ADAT or S/PDIF depending on the specification of the external device. Finally, ensure your sample rates match.

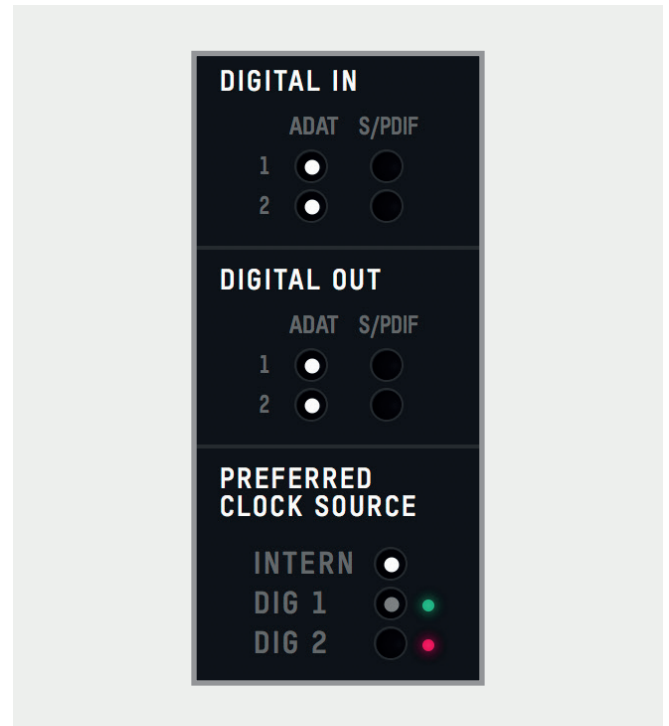

## iD44 clocked via the Optical Port

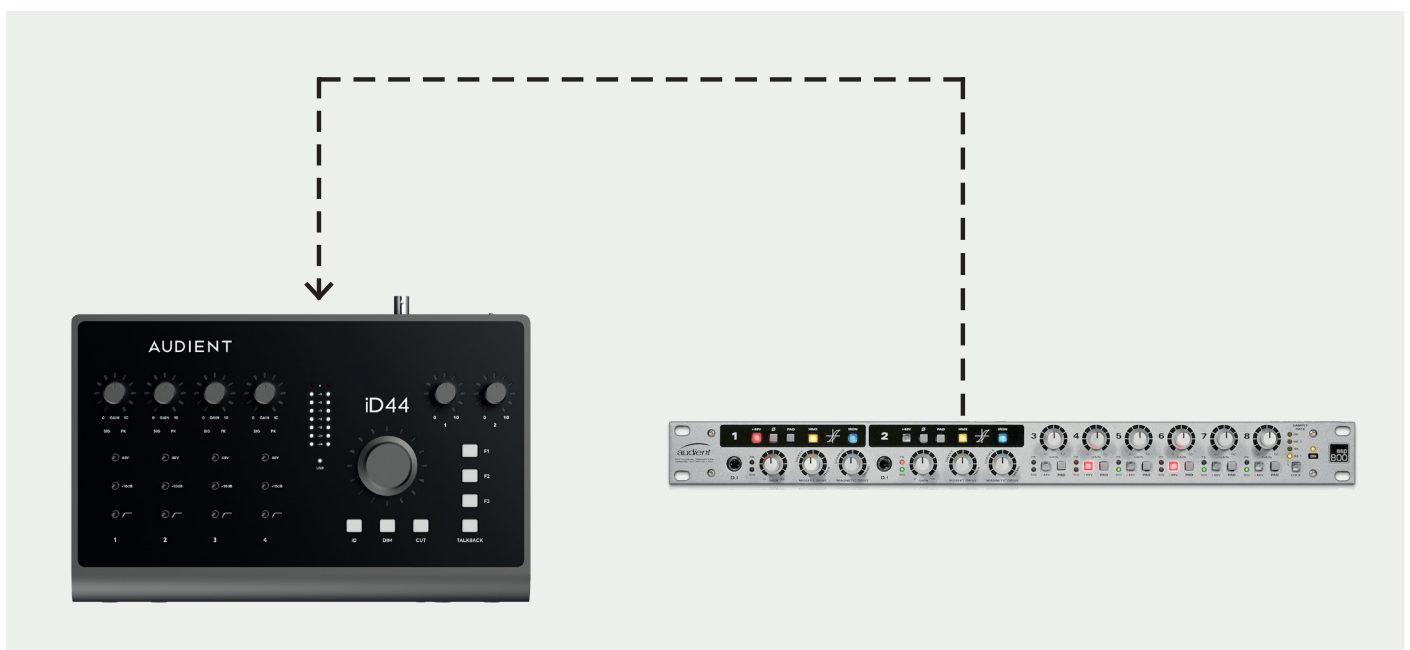

## Line Outputs

iD44 has four line outputs, these can be used for connecting monitors on the back panel in the form of balanced TRS jack connectors. The outputs are impedance balanced using the same topology as our flagship console, the **ASP8024-HE**.

The outputs are fed from high quality DACs (Digital to Analogue Converters) sending clean, linear audio to your speakers, perfect for critical listening.

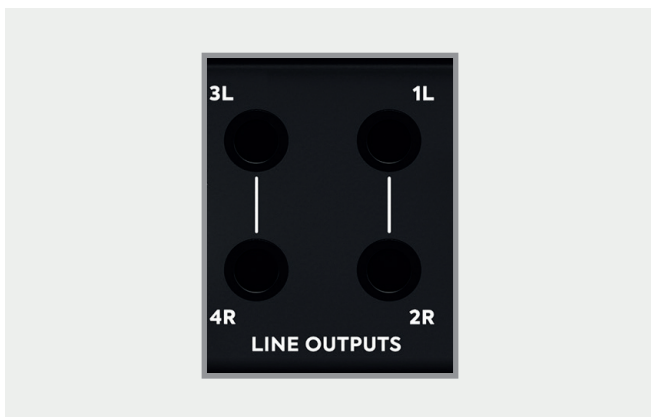

You can use these outputs for more than just speakers. If you want to use hardware outboard equipment, you can send out up to four mono, or two stereo signals from these outputs, this is configured in the iD Software Mixer.

In order to keep your audio noise free, we would recommend against the use of unbalanced (TS, RCA.. etc) cables on the line outputs.

## Headphone Outputs

iD44 features two high current headphone amplifiers which are fed by separate DACs. Headphone Output One can be accessed from both the 3.5mm and 6.35mm sockets found on the front of the unit. The same audio signal comes out of both connectors simultaneously, so it does not matter which you plug your headphones into. You can also plug in two pairs at the same time.

Whilst Headphone Output Two can only be accessed via the 6.35mm output.



These can be used instead of or alongside speakers to get an idea how your mix translates to headphones, or to provide artist headphone mixes

The headphone outputs can comfortably drive a wide range of headphone impedances meaning that you will get great sounding audio no matter what model of headphones you have.



## Monitor Control

iD44 provides excellent monitor control functionality as found on our consoles.

As such, it is possible to control main and alternative loudspeaker volumes with a perfectly matched stereo volume control.



Accompanied by this monitor volume knob are permanently assigned hardware DIM & CUT switches. The level of DIM and ALT. loudspeaker trim can be adjusted in the iD Mixer application.

Alongside these functions, three user programmable 'F' keys provide access to several useful monitoring features.

## Monitor Control Features

- Volume control (perfectly matched)
- ALT loudspeaker with programmable level (assignable to an 'F' key)
- DIM with programmable level
- CUT
- Mono Sum (assignable to an 'F' key)
- Polarity reverse (assignable to an 'F' key)

By using polarity reverse and mono sum it is possible to listen in sum or difference (mid or side) modes. This provides an excellent way to check mono compatibility and to also learn spatial tricks from your favourite reference material.



## iD Button



The iD button switches iD44 into **ScrollControl** mode, allowing the encoder to be used as a scrollwheel for the computer. This gives you the ability to control plugin parameters and anything else that is scrollable. This works well for adding automation or setting parameters in a hands-on way.

To use **ScrollControl**, hover your mouse over whatever you want to control and rotate the encoder.

**ScrollControl** may act slightly different on different plugins or DAWs depending on how they have been programmed to work with scrolling. If you find it is too sensitive or not sensitive enough, you can try adjust your computer scrolling speed.

## Talkback

The iD44 can take a talkback signal from a variety of places. You can assign one of the 4 analogue or 16 digital inputs as your talkback channel. When talkback is activated, signal from that channel is sent through one of the Cue mixes to the artist(s).



You can also source the talkback audio from another audio device connected to your computer such as the built-in microphone. This allows you to free up an input channel on your iD44 that would otherwise be taken up, great for big sessions.

Details on how to set this up can be found in the 'Software' section of this manual.

## Hardware Metering

The 8-segment hardware meters indicate playback level of the iD Mixer app, so it is suggested that end users observe their DAW metering for input levels.

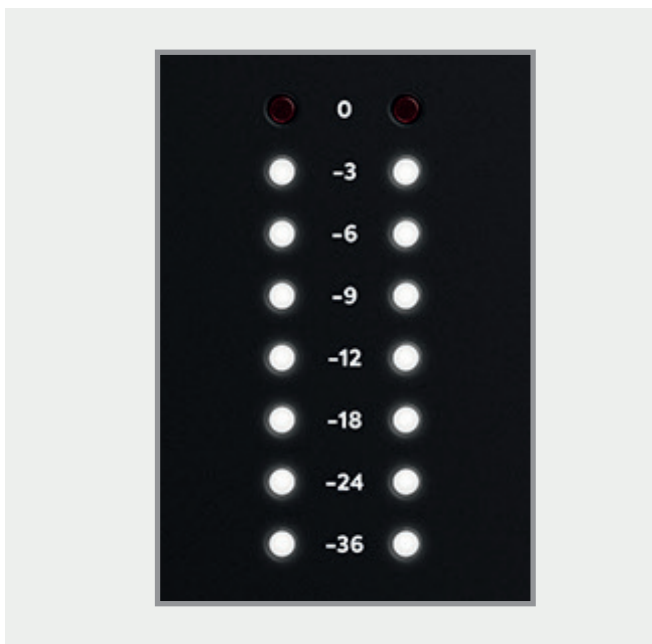

## Kensington Lock

For those who work in educational establishments or in situations where your equipment is public facing and subject to possible theft opportunities, we have provided a Kensington lock hole to enable you to protect your iD44.



## Status LED

The status LED indicates connection via USB to your computer. A solidly lit light means that there is stable communication between iD44 and your computer.

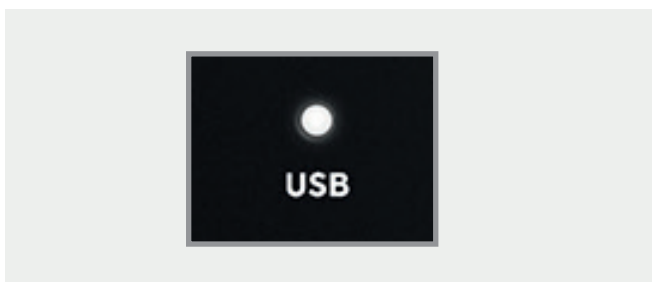

# Software Features

## Input Channels - Channel Types

The iD Mixer application features three types of input channels:

### Mic Inputs

These are the inputs where you will see the signal from the iD44's four analogue inputs

### Digital Inputs

These are the inputs from the iD44's optical inputs. The number of digital inputs present on the iD mixer application depends on the digital input type (S/PDIF or ADAT) and the sample rate being used.

### DAW Returns

These are the signals being played back from your DAW. The iD44 has 8 DAW Return Channels allowing you set up multiple cue mixes or sends to hardware outboard gear.

Using these three channel types, you can build up your main monitor mix and up to four additional cue mixes.

Its important to note that the iD mixer application only controls the monitoring of the iD44. Changes made to the iD mixer application won't affect the level present in your DAW or audio software.

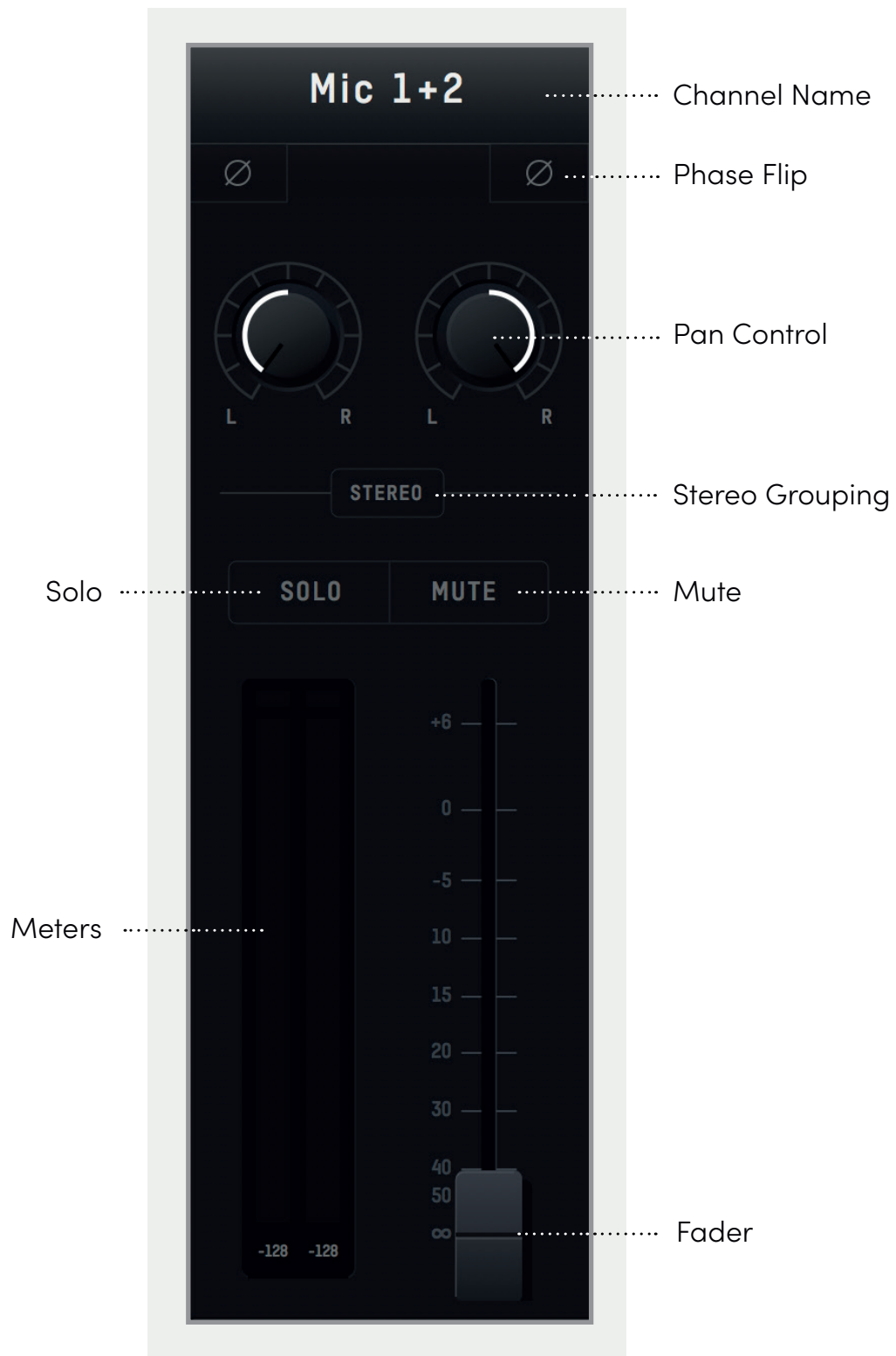

## Channel Features

### Channel Name

By double clicking on the name of the channel you can rename it to help you organise your iD mixer application. You could name a channel 'Kick' or 'Snare' for example.

### Phase Flip

Inverts the polarity of the signal by 180° to stop phase cancellation. This is useful if you are micing the rear of a guitar amplifier or the underside of a snare drum.

### Pan Control

Allows you to send the audio to the left, to the right or anywhere between on your Main Monitor Mix or Cue Mixes.

### Stereo Grouping

Allows you to group two adjacent channels together into a stereo channel with a single fader controlling the level of both channels. When a channel is stereo grouped, the pans will automatically be set to far left and far right.

### Solo

The Solo button mutes all other channels other than the one that is currently solo'd. Multiple channels can be solo'd at one time.

### Mute

The Mute button stops this channel from outputting audio whilst it is engaged.

### Fader

The fader controls the amount of signal that is sent to the currently selected mix. This can be set to anywhere between -inf dB to +6dB.

### Meter

The meter shows the current signal level in dBFS. Should the signal level exceed 0dBFS then the peak indicators will illuminate red to indicate a peak. The peak indicators can be cleared by clicking the mouse cursor in them. You can also clear all peak indicators using

**Alt + Click.**

# Master Section Features

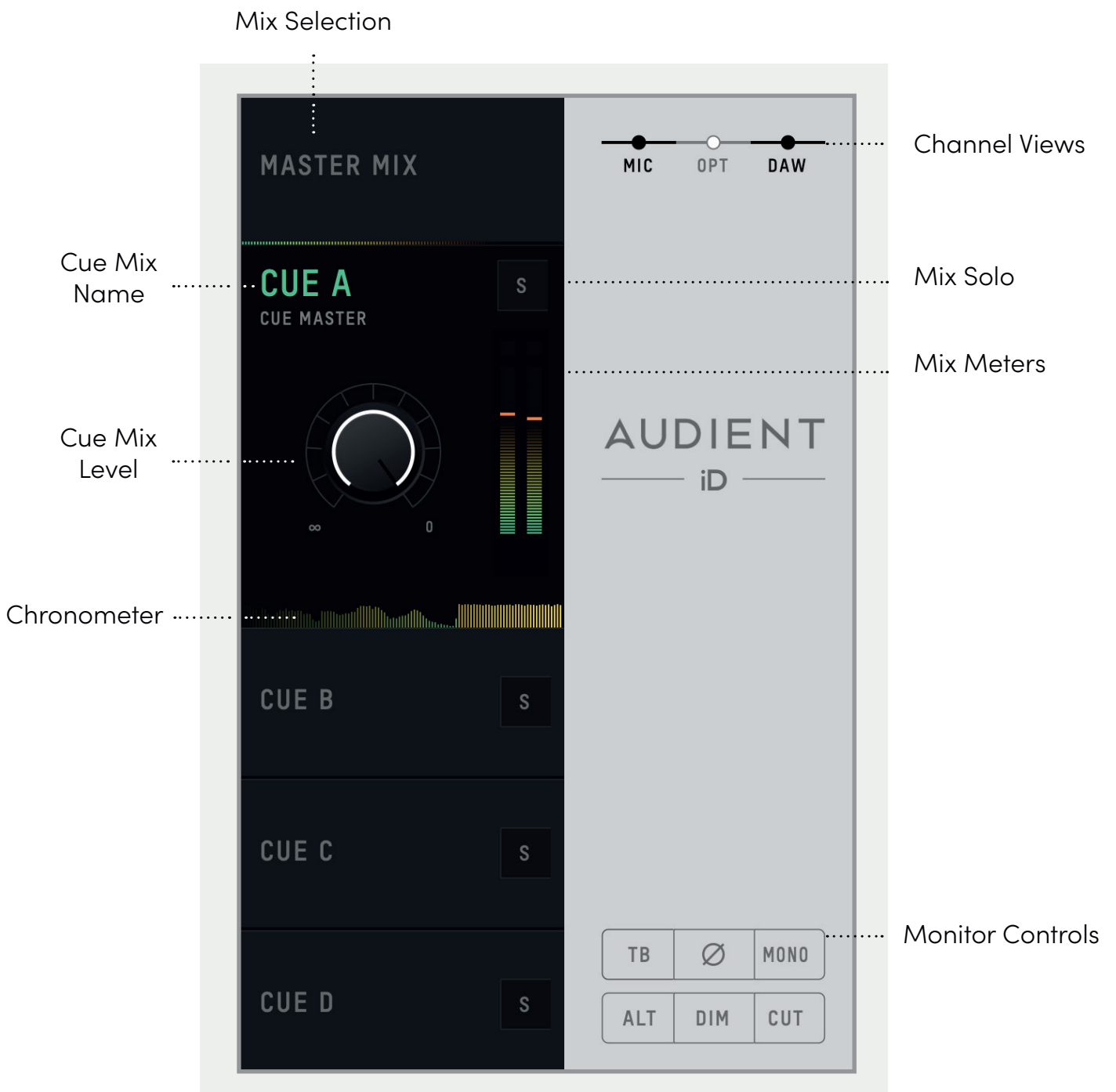



## Channel Features

### Mix Selection

Clicking on one of mixes allows you to make changes to that mix. When a mix is selected, it expands to reveal additional controls for that mix.

### Cue Mix Name

Double clicking on a Cue Mixes name allows you to rename the Cue Mix. If for example you were creating mixes for four separate band members, you could name them 'Drummer', 'Guitarist', 'Bassist'... etc.

### Mix Solo

The Solo button allows you to audition each of the Cue mixes through your monitors.

### Mix Level

The Mix level allows you to control the overall level of the Cue mix that is sent to the outputs.

### Mix Meters

The Mix meters show the master signal level of the selected Mix.

### Chronometer

The Chronometer Meters allows you to see not only the current signal level but also the signal level from a few seconds previously.

This can be great to track down a sudden

loud transient on a particular cue mix or to monitor the change in level over time as you make changes to a mix.

## Channel Views

These three buttons allow you control which of the three channel types are shown in the mixer. If for example you weren't using the digital inputs for a particular project, you can simply hide the optical channels by clicking on the OPT control.

## Monitor Controls

These six buttons control various aspects of the iD44's monitor controller capability. The function of each control can be found below:

- TB (Talkback)  
The Talkback button switches Talkback on and off. More information regarding Talkback and its various settings can be found in the 'System Panel' section of this manual.
- ø (Phase Flip)  
Pressing this switch flips the phase of one side of the stereo field. Used in conjunction with the mono button, this can be a great way to remove centred elements from a mix in order to hear the hidden elements of a mix.

## Mono

The mono button sums the stereo outputs down to mono. This can be used to quickly check the mono compatibility of your mix to make sure it'll sound great almost anywhere!

## ALT

ALT allows you to quickly switch your monitor path to a secondary set of monitors to let you check how your mix translates on various speakers.

You can select which outputs the ALT monitor control flips to in the System Panel.

## Dim

Reduces the output level by a pre-set amount, which can be great if you get a call or need to quickly chat to someone during a session.

## Cut

The cut button cuts the signal to the monitors.

All these controls can be controlled from the iD44 itself, either by assigning them to an F-Key, or using the dedicated Talkback, Dim and Cut controls.

## Assigning F-Keys

Various functions of the iD mixer application can be assigned to the Function Keys of the iD44 to allow you to quickly control your monitoring at the click of a button.

To assign a monitor control to an F-Key, simply right click on the control and select the F-Key.

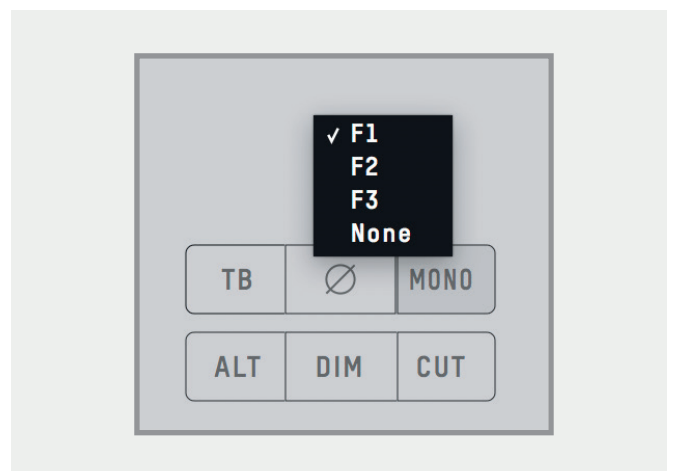

# System Panel Features

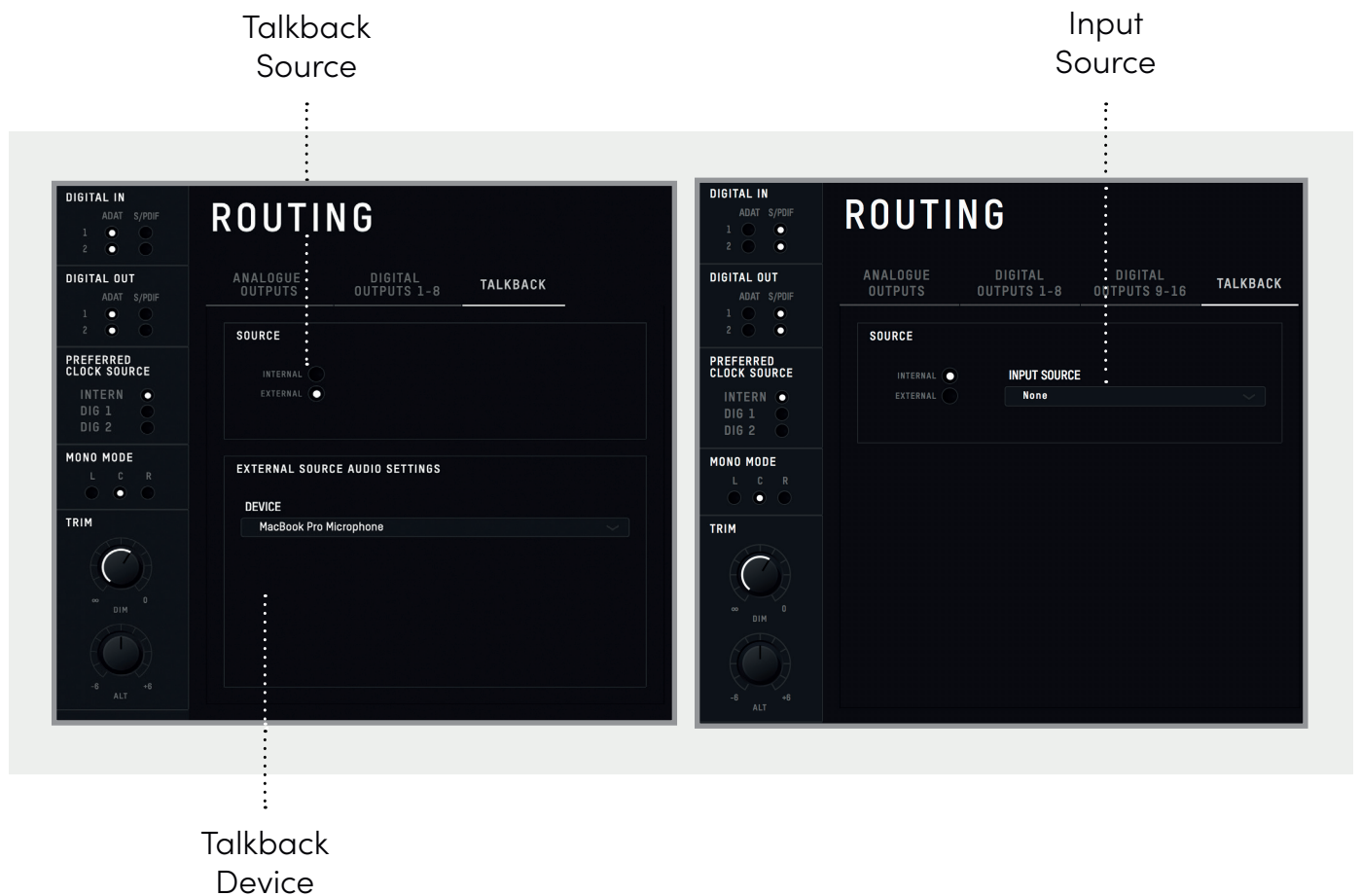
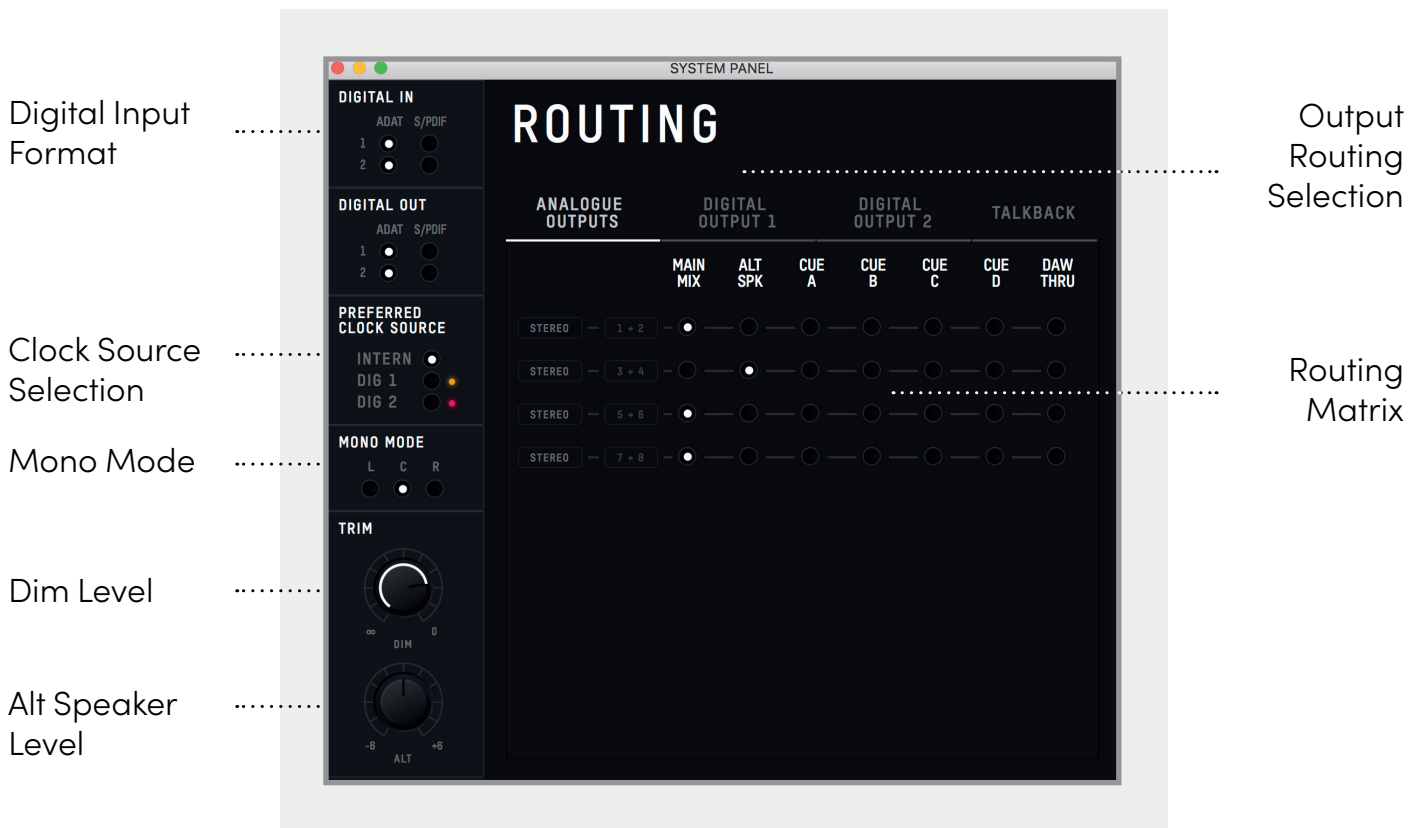

## System Panel Features

### Digital I/O Format

Allows you to select whether each optical input or output uses ADAT or S/PDIF digital format.

### Preferred Clock Source

The Clock source can be selected from either the internal clock or one of the two optical inputs. More information about choosing a clock source can be found in the clocking section of this manual.

When using an external clock source the indicator beside the selector shows the current status of the clock on that input.

- Red - No clock signal detected on input
- Amber - A clock signal is detected but at a different sample rate to iD44
- Green - A clock signal is detected and is at the correct sample rate.

For an external clock source to be working correctly you would want the indicator to be green. If the indicator isn't green, iD44 will default back to the internal clock until it detects a valid clock input.

### Mono Mode

When the iD44's Mono feature is engaged this option controls whether the mono signal is sent to the left, right or both monitors.

### Dim Level

When the iD44's dim button is pressed, this control defines how much the level is reduced by.

### ALT Speaker Level

This control defines the level drop/boost when the iD44 is switched to ALT speaker mode. This is used to balance levels between different speaker brands or types.

### Output Routing Selection

Opens the routing matrix for either the Analogue Outputs, Digital Output 1, Digital Output 2 or the Talkback channel.

## Routing Matrix

The Routing Matrix allows you to control the audio source for each of the iD44's outputs from the following options:

- Main Mix - This takes signal from the Master Mix of the iD mixer. This is what is usually used for most standard playback.
- ALT - This takes signal from the Master Mix but only when the Alt speaker mode is active.
- Cue A, B, C, D - This takes signal from the four cue mixes which can be created using the iD mixer. Please note that the hardware volume control does not affect these mixes and the Cue's have separate trims which can be adjusted when the cue mix is selected in the Main Mixer Window.
- DAW THRU - This allows you to route to outputs exactly as they would appear in your DAW. For example, if you set

Analogue out 1+2 to DAW THRU, anything your DAW sends out to Outputs 1+2 will be sent directly to Analogue outputs 1+2. This can also be applicable for the digital outputs meaning you can have numerous sends direct from your DAW out via the optical outputs for adding outboard gear or for extensive fold-back solutions. As an example, setting digital outputs 1+2 to DAW THRU would allow you to directly send audio to this output from your DAW by setting channels in your DAW to playback via outputs 9+10 (outputs 1-8 would be your analogue outputs). Digital outputs 3+4 would be outputs 11+12... and so on.

Please note that in DAW THRU, the channel in question will bypass any volume control and audio will be passed at full scale. If this output is sent to a set of monitors without inline attenuation, this may be very loud.

The only exception to this is the headphone outputs where the volume control will still function.

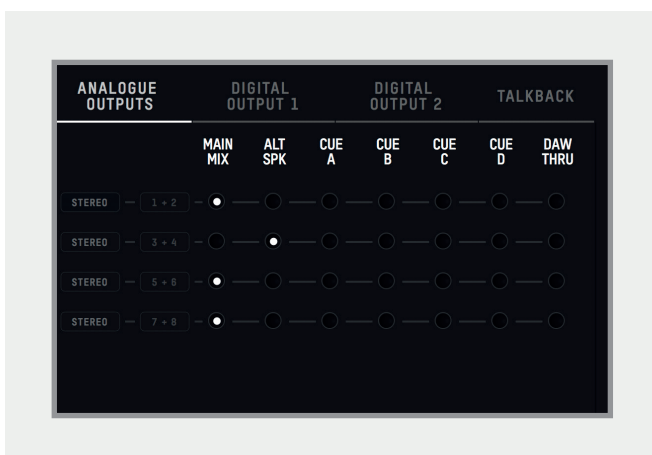

## Talkback Source

The Talkback source allows the talkback input to be taken from one of the iD44's internal inputs or from a device connected to the host computer (such as a built-in microphone or USB microphone).

When you select an input as your Talkback channel, the channel strip in the iD mixer will be changed to a talkback channel which will have a **TB** button in the centre.

If using an external device, the talkback signal will appear on channel **DAW 10**.

Faders will only appear for these channels on the Cue mixes, not on the Main Mix.

## Talkback Device

If an external device is selected then this allows you to select which connected device is used.



## Saving & Loading Mixer Presets

To allow you to quickly setup your iD Software Mixer during a session you can save and load various presets. This is great if you are moving between different recording scenarios quite often.

Mixer presets can be saved and loaded in two ways:

- Using the File menu and selecting either Save or Open.
- Using standard keyboard shortcuts :

Save: Mac - **Cmd + S**

Windows - **Ctrl + S**

Load: Mac - **Cmd+ O**

Windows - **Ctrl + O**

## Saving a Preset

To save a preset, simply setup your mixer the way that you'd like. Then select **File > Save** as explained above. The mixer window then presents the Save dialogue.

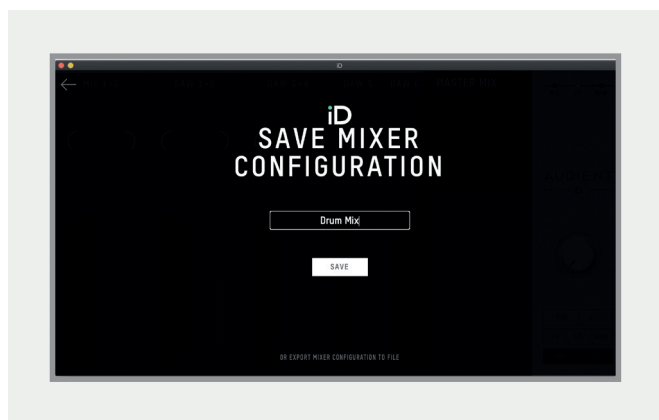

Simply enter the name of your preset and press save.

It is also possible to export your preset files in order to send them to friends or to simply save them within your DAW session files for easy recall later on. To do this, select **Export Mixer Configuration** at the base of the Save screen.

## Loading a Mixer Configuration

To load a previously saved preset, select **File > Open** to bring up the Load screen.

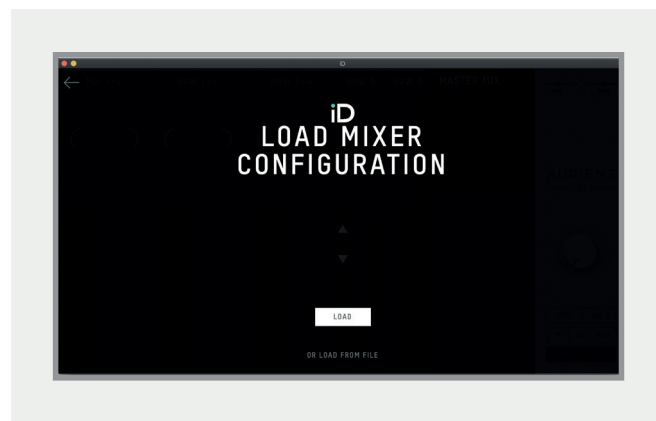

The previously saved configuration will appear in a list. Select the configuration you wish to use and click Load.

You can also open a mixer configuration directly from a file by selecting **Load From File**.

## Menu/Task Bar Icons

### MacOS

On MacOS, the iD icon appears in the menu bar in the top right hand corner of the screen. This gives you quick access to various functions of the iD44.

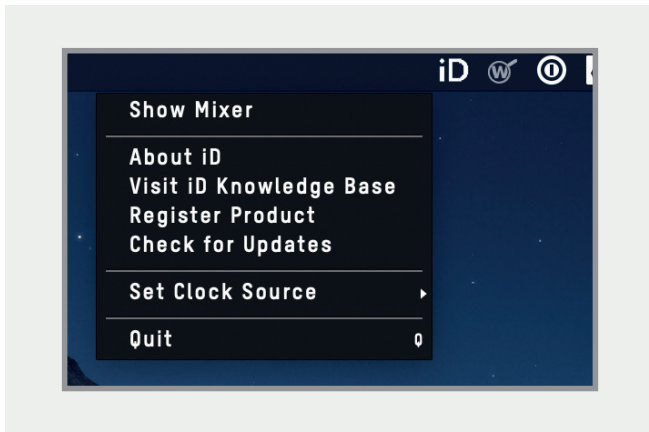

### Quit

Fully closes the iD mixer application.

### About iD

Displays information regarding the current version of the iD mixer application.

### Visit iD Knowledge Base

Opens a browser window for the Audient Helpdesk with helpful articles and FAQ's.

### Set Clock Source

Allows you to quickly adjust the clock source between the internal and optical clocks.

## Check for Updates

The iD app will check with the Audient update server for any available firmware updates for iD44.

### Windows

The Windows system tray icon has all the options of the MacOS menu bar icon but also includes some Windows specific options.



### Set Sample Rate

Sets the operating sample rate of iD44. 44.1, 48, 88.2 and 96kHz are the four options available.

### Set ASIO Buffer Size

Sets the buffer size of the iD44 between 16 and 8192 samples. Higher sizes will take processing load off your computer but will cause increased latency.



## Standalone Operation

If you would like to use iD44 without a host computer, iD44 can be configured to operate in standalone mode. This is great for setting up complex tracking setups in remote locations.

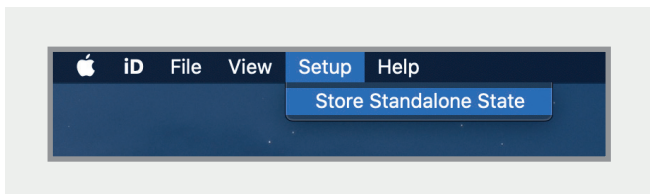

To setup Standalone mode, first setup the iD mixer in the way that you wish to be saved onto your iD44. This includes your digital I/O settings, output routings and talkback settings in the System panel.

Now navigate to the Setup menu and select **Store Standalone State**. The iD Software Mixers current configuration will then be saved onto the iD44 itself, ready to be recalled when the iD44 is next powered on.

## Firmware Update

Occasionally, Audient will release a firmware update for the iD44 in order to, improve compatibility, add new features and address bugs. Therefore you may wish to check occasionally for any updates.

This can be accessed by navigating to either the Menu bar on Mac, or the system tray on Windows and selecting **Check for Updates**.

The iD Software Mixer application will then check with [audient.com](http://audient.com) for any available updates. If there are, you will be prompted to install them onto the iD44.

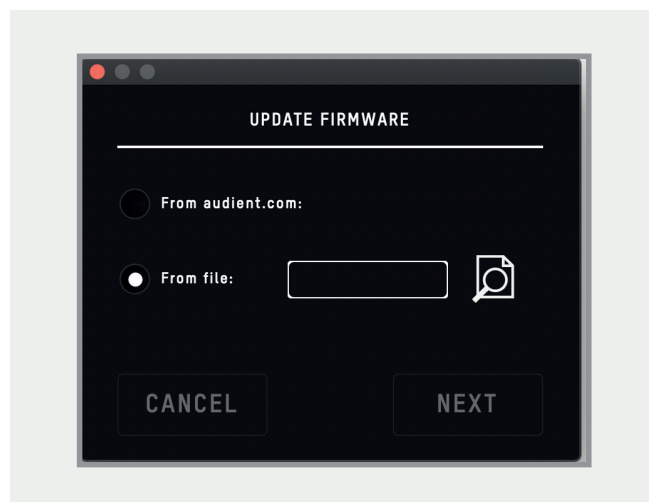

If you then click next, you'll be requested to stop any playback through the iD44. Click Update and the update will begin. The iD44 may turn off a number of times. Therefore, we recommend powering off any monitors.

# Audio Loop-back

Another feature of the iD44's Mixer Application is the ability to loop-back audio so you can record or stream audio from different applications on your computer using the dedicated Loop-back channels.

These Loop-back channels are input channels 21+22 and using the "Input Routing" option found in the "Setup" menu of the iD mixer, you can then select the audio source to be sent to these Loop-back channels.

## On macOS:

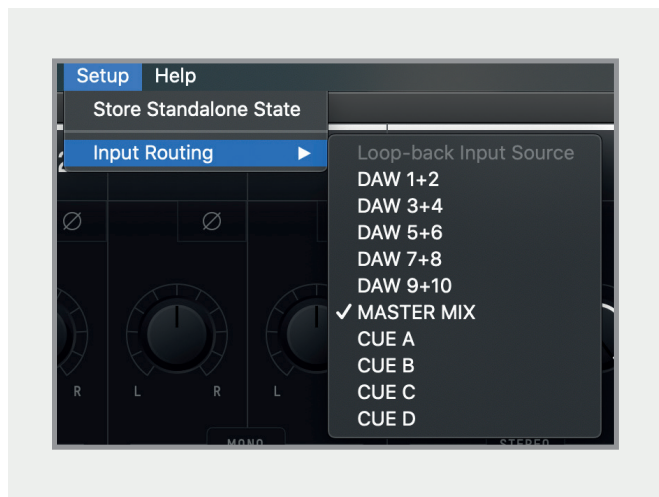

The various sources you can select from in the menu are as follows:

- **DAW 1+2** - Any audio being sent to outputs 1+2 of the iD44
- **DAW 3+4** - Any audio being sent to outputs 3+4 of the iD44
- **DAW 5+6** - Any audio being sent to outputs 5+6 of the iD44
- **DAW 7+8** - Any audio being sent to outputs 7+8 of the iD44
- **DAW 9+10** - Any audio being sent to outputs 9+10 of the iD44
- **Master Mix** - The audio mix created in the iD mixer on the Main Mix panel
- **Cue A** - The audio mix created in the iD mixer via the CUE A panel
- **Cue B** - The audio mix created in the iD mixer via the CUE B panel
- **Cue C** - The audio mix created in the iD mixer via the CUE C panel
- **Cue D** - The audio mix created in the iD mixer via the CUE D panel

## On Windows:



## Using the Loop-back Mixer

To record or stream your Loop-back mix in your audio software, you need to select the Loop-back channels as your input channels in your audio software. Depending on the software you are using, they may appear as either Loop-back 1+2 or Input 21-22. For example the image below shows how you would select the Loop-back input in Logic Pro X.

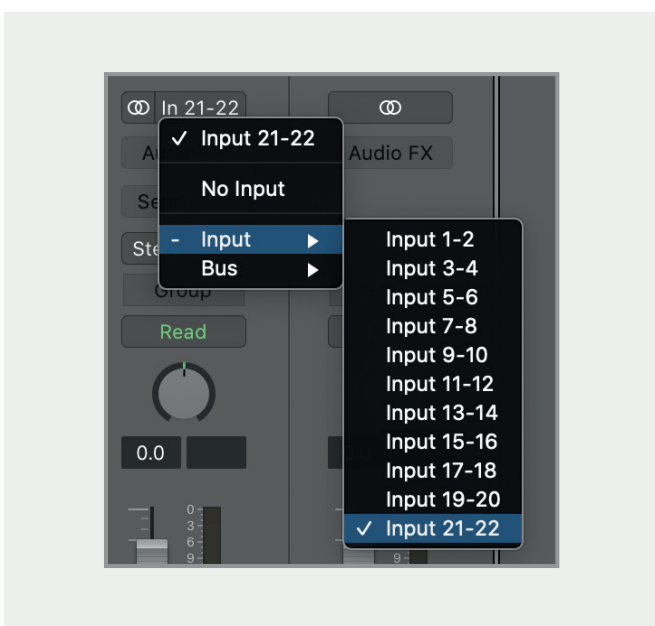

A similar process would be used in other software. If you are unsure on how to adjust the input on your audio software, we'd recommend referencing the user manual for your software. On Windows, you may also need to adjust the audio device in your System settings from Analogue 1+2 to Loop-back 1+2.

**Please note:** Some software will not allow you to adjust the input channel you are using and will just default to Channels 1+2. This limitation with some software can stop you from using Loop-back with this software as you are unable to select Channels 21+22.

## Recording/Streaming your Loop-back Source

Once you have selected the Loop-back Inputs as your audio source in your recording/streaming software, you can now setup your Loop-back mix using the iD Mixer.

The first step is to decide which source you will use for your Loop-back stream.

If you wish to combine audio from your computer and microphones/instruments into a single mix then selecting either the Main Mix or one of the Cue Mixes is the best option as you can use the faders in the mixer to send multiple channels to the same Mix.

For example, below you can see the CUE A mix being used as the Loop-back source with the Mic 1 and DAW 1+2 being sent to the CUE A mix. When recording the Loop-back inputs with this setup, you would hear both the Mic Channel and the Computer Playback on a single stereo channel.



Otherwise, if you only wish to send audio from the computer without any mic signal you can just use one of the DAW Channels.

When selecting a Channel or Mix as the loop-back Source, a small loop-back icon will appear on that channel/mix so you can check where the loopback is being fed from with just a quick glance.

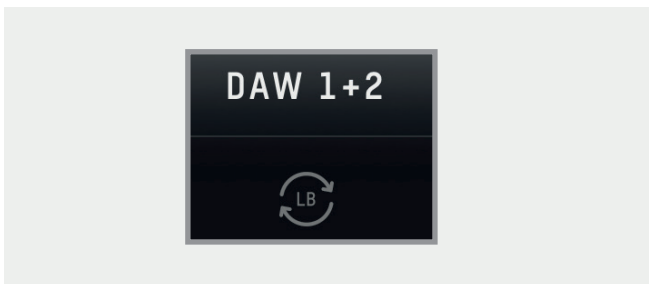

## Adjusting your Output Channels

When setting up your Loop-back mix, you may wish to setup your computer audio output so it is sent to DAW 3+4, DAW 5+6, DAW 7+8 or DAW 9+10 in order to keep it separate from your Main Monitor Mix which typically will be sent to DAW 1+2.

In most DAW software, you should be able to create a new output send or adjust the output channel. The process to do this will vary so we recommend that you reference the user manual for your chosen software on how to adjust the output channel.

On Applications that don't give the option to adjust the output channels (Media Players, Video calls...etc) then you may need to adjust this in the Operating System Settings.

### On macOS:

Open Finder and navigate to **Applications > Utilities > Audio MIDI Setup**. In the Audio MIDI Setup Utility, select the iD44 MKII from the list of devices. Select the Output Tab and then click "Configure Speakers". You can then select which channels on the iD44 you wish to be your left and right outputs. Channels 3+4 will relate to DAW 3+4, Channels 5+6 will relate to DAW 5+6...etc.

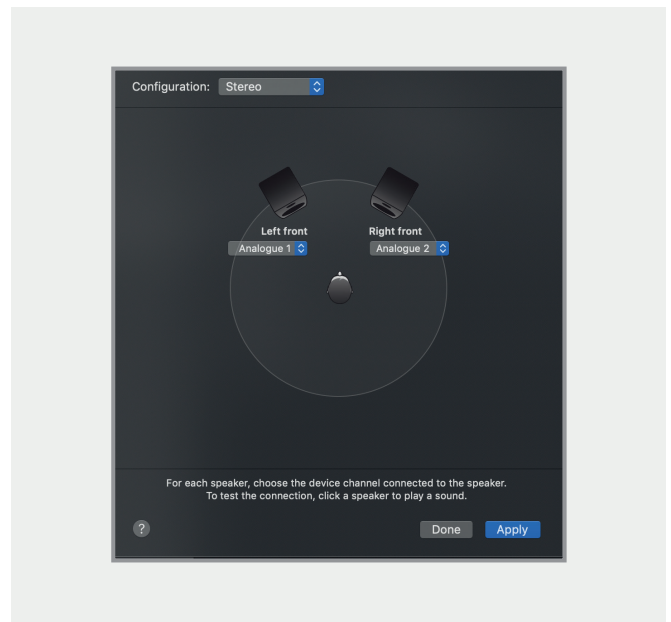

### On Windows:

Open the Start menu and select the Settings. In the Settings navigate to **System > Sound > Sound Control Panel**. Using the "Output Device" drop down menu, you can select the channels you wish to use for your Output. Again, channels 3+4 will relate to DAW 3+4, Channels 5+6 will relate to DAW 5+6...etc.

# Keyboard Shortcuts

## Keyboard Shortcut Index

To allow you to find all shortcuts for the mixer application in one place without having to go through each page of this manual please refer to this table:

Location	Mac	Windows	Description
Faders	Alt + Click	Alt + Click	Resets fader to unity gain (0 dB)
Pans	Alt + Click	Alt + Click	Resets pan pots to central position
Solos	Cmd + Click	Ctrl + Click	Clears all solos if clicking on a solo'd channel Overrides all other solos (for solo exclusive) if clicking on an unsolo'd channel
Meters	Alt + Click	Alt + Click	Clicking on peak hold indicator will clear all clip indicators
System Panel	Cmd + S	Ctrl + S	Save mixer configuration
	Cmd + O	Ctrl + O	Load mixer configuration
View Modes	Cmd + 1	Ctrl + 1	View Mic/Line Input
	Cmd + 2	Ctrl + 2	View Optical (Digital) Inputs
	Cmd + 3	Ctrl + 3	View DAW Mix Inputs
	Cmd + 4	Ctrl + 4	View System Panel

Please check the iD44 page online at [audient.com/products/iD44](https://audient.com/products/iD44) for the latest mixer application updates.

More shortcuts may be added without notification.

# DAW Setup

# Pro Tools Setup

## Operation with Pro Tools

Once iD44 has been successfully installed following the steps detailed in this manual, launch Pro Tools and ensure that a new session is created at the desired sample rate (if clocking internally) or at the rate of the clock source (if clocking externally).

If using Windows, make sure that you have set the correct latency and buffer size settings in the iD app before opening a project. Changing these settings will result in ProTools needing to restart.

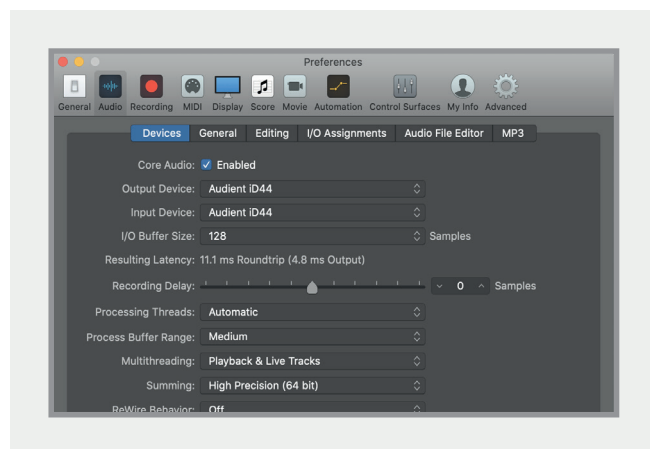

## I/O Setup

Go to **Setup > I/O...** to label your inputs and outputs and ensure that iD44 is correctly reporting 20-inputs and 24-outputs to and from Pro Tools. Note that analogue outputs 1-8 are the DAW playback channels in the iD mixer and can either be routed through the iD mixer or hard-wired directly from Pro Tools to the physical outputs.

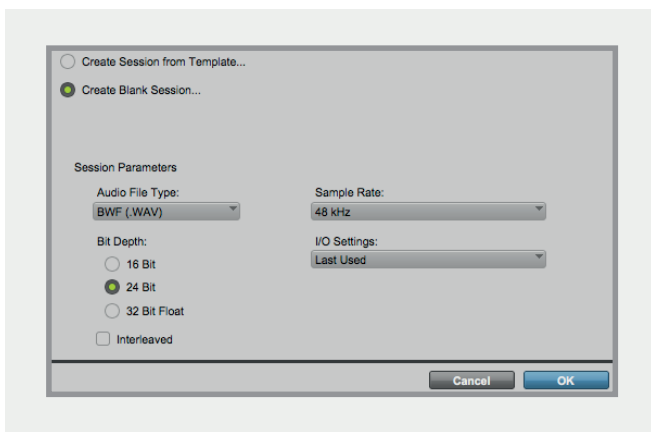

## Playback Engine

Go to **Setup > Playback Engine...** and ensure that iD44 is set as the active playback device.

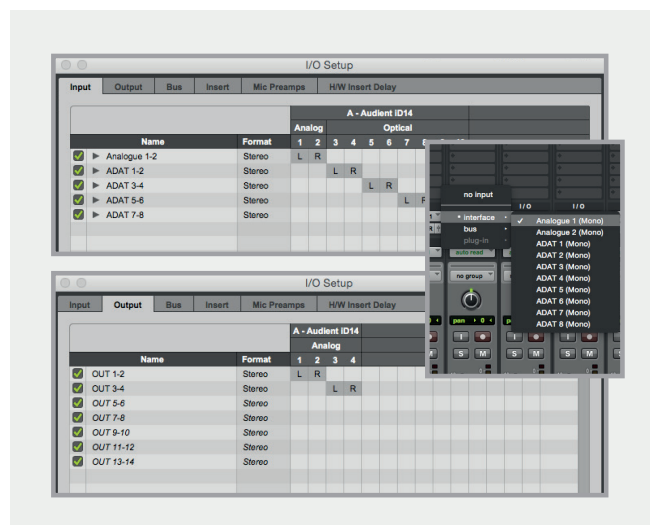

For more Pro Tools information consult your Avid user manuals & documentation.

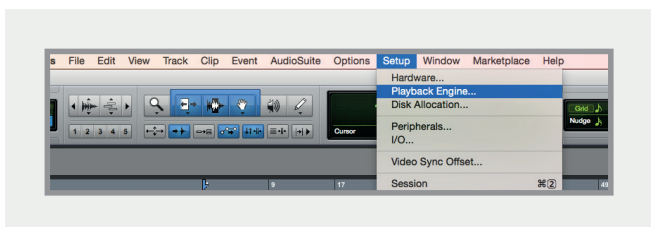



# Logic Pro Setup

## Operation with Logic Pro

Once iD44 has been successfully installed following the installation process that can be found at the start of this manual, launch Logic Pro and check the following:

### Logic Pro > Preferences > Audio

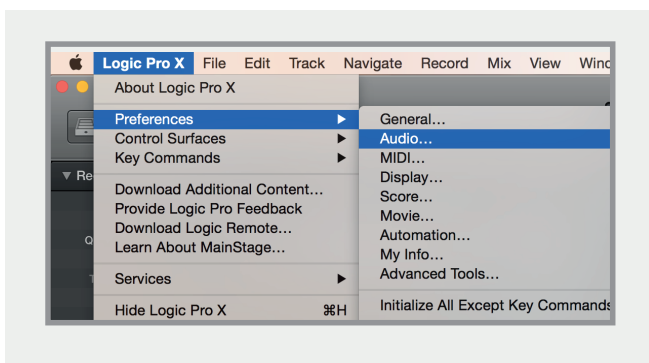

Ensure that iD44 is selected as the active audio device and set the buffer size (to affect system latency). If you are experiencing issues with playback stability and CPU loading, try increasing the buffer size. This appears with “overload” errors and/or pops and clicks and distortion in the audio.

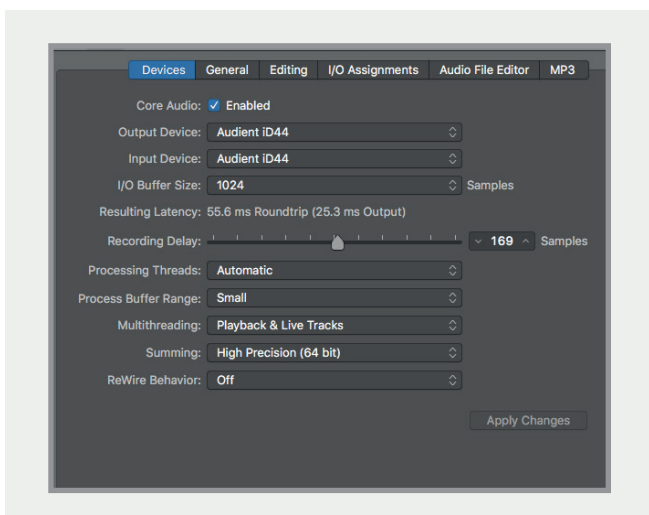

If you are using the iD mixer to monitor input signals while recording, be sure to disable Logic’s software monitoring to avoid phasing as the same source will be heard twice with a short delay between the low latency DSP signal and the delayed software monitoring signal.

## Assigning I/O

All of iD44’s input and output channels will be available to Logic for routing. There are a total of 20-inputs and 24-outputs reported from the driver. You can rename input and output channels to whatever you wish using the I/O label function. This is a great way to keep things organised.

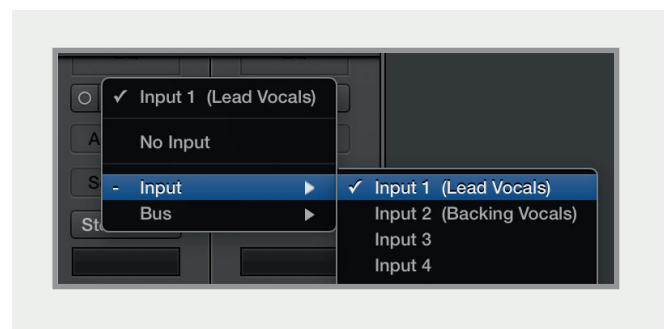

## Mix > I/O Labels

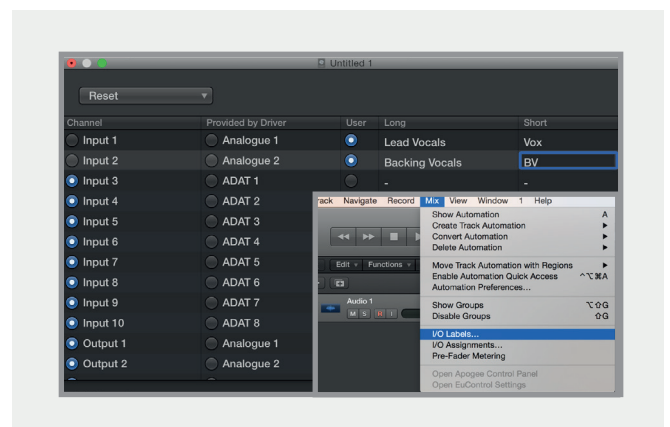



## Operation with Logic Pro

If you are using an external clock source (ADAT or S/PDIF) to clock iD44, please ensure that your Logic Pro project is set to the same sample rate when recording and playing back in a session, otherwise things may sound a bit sharp or flat!

### File > Project Settings > Audio

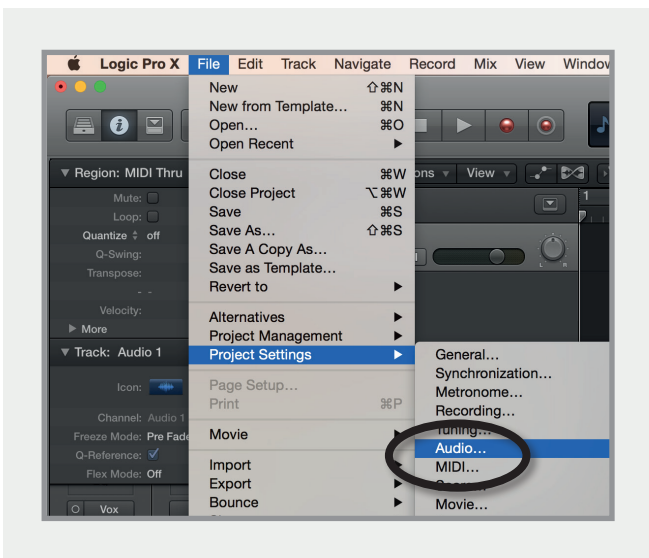

If you are using the internal clock in iD44, setting the sample rate via Logic Pro will update the iD44 sample rate to follow your session.

There may be a slight pause as the system re-clocks. This is normal.

This can be verified in Audio MIDI Setup.

## Macintosh HD > Applications > Utilities

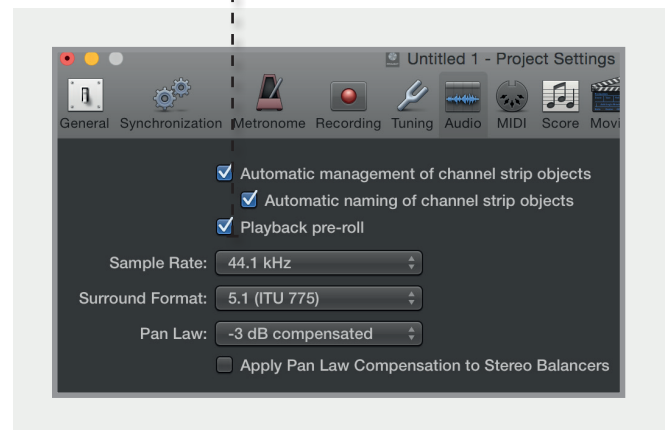
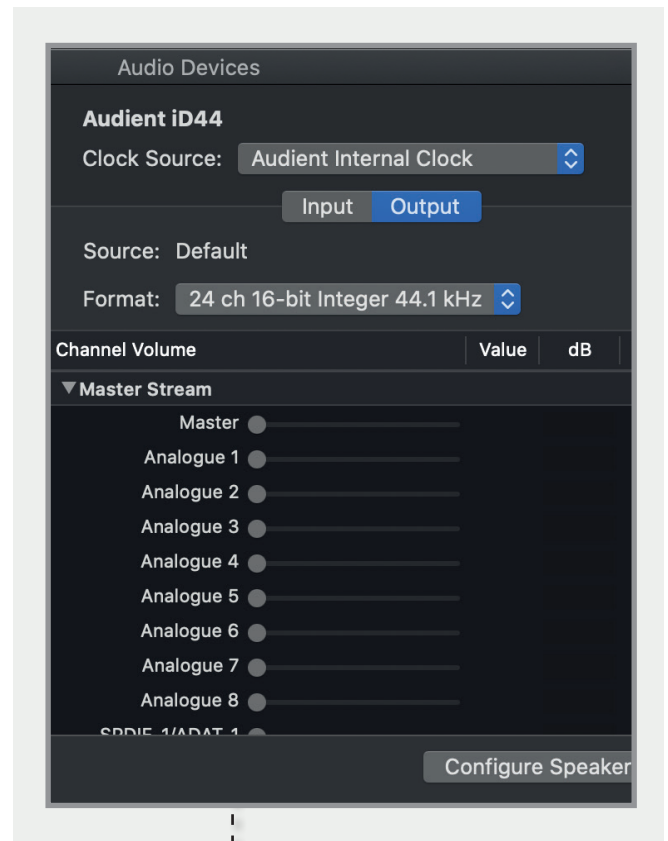

For more Logic Pro information please consult your Apple user manuals & documentation.



# Cubase/Nuendo Setup

## Operation with Cubase / Nuendo

Once iD44 has been successfully installed following the installation process that can be found at the start of this manual, launch Cubase or Nuendo and head straight for the Devices menu:

### Devices > Device Setup...

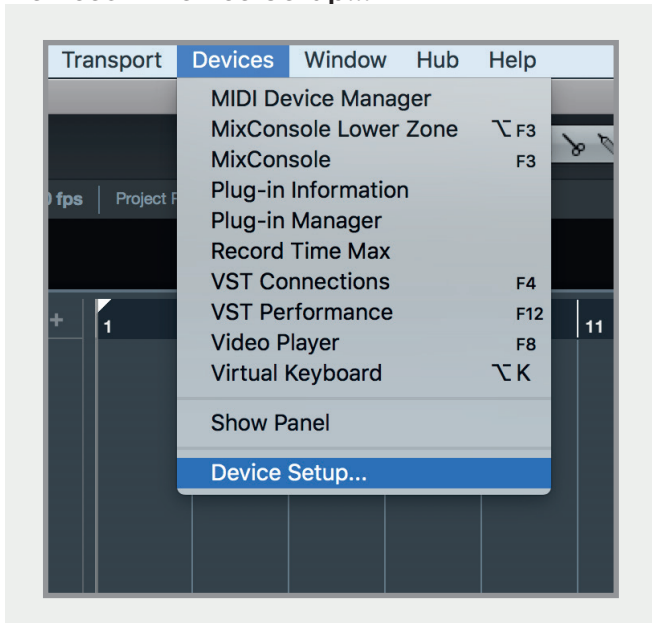

Select VST Audio System from the list of options

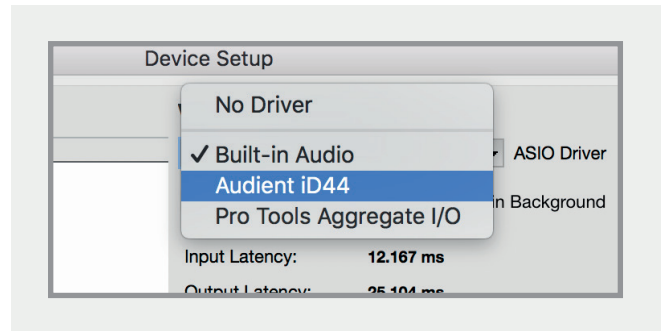
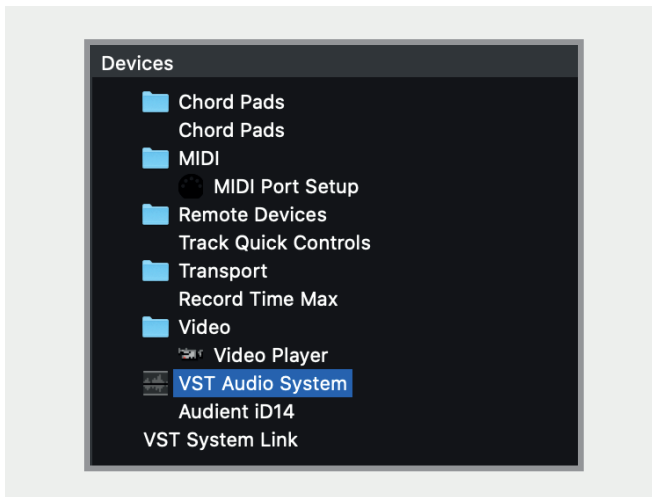

Select Audient iD44 in the menu to ensure that Cubase / Nuendo addresses the iD44 device driver. You will be asked if this is OK, select 'switch'.

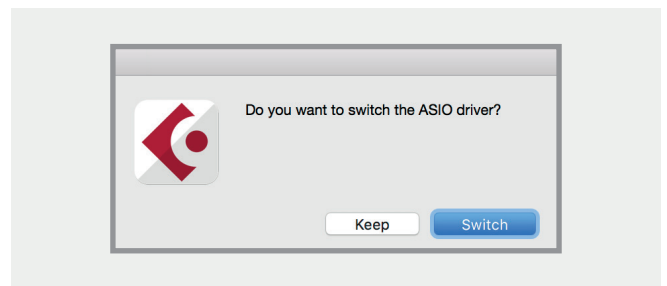

Select Audient iD44 in the devices menu...

Here you will see the main iD44 information, where clock sources can be set as well as activating i/o ports. Be sure to click Externally Clocked if clocking from another digital device via ADAT or SPDIF.



# Cubase/Nuendo Setup

## Operation with Cubase / Nuendo

Buffer sizes can be set in the control panel within the VST devices display. It is ideal to keep them quite high to reduce CPU loading if you use the iD mixer as the input monitoring device while recording.

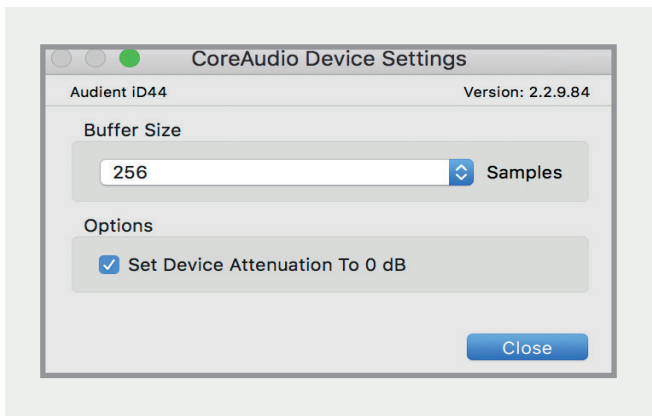

I/O ports can be renamed in the device panel such that they better represent what you connect to them (for example Main Monitors, Headphones). This is useful as any names chosen here will be those displayed when assigning i/o on track input/output channel routing.

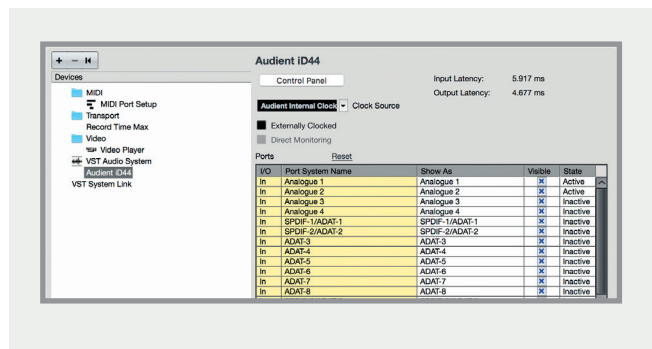

Close the VST device setup panel and navigate to the VST connections panel:

## Devices > VST Connections (F4)

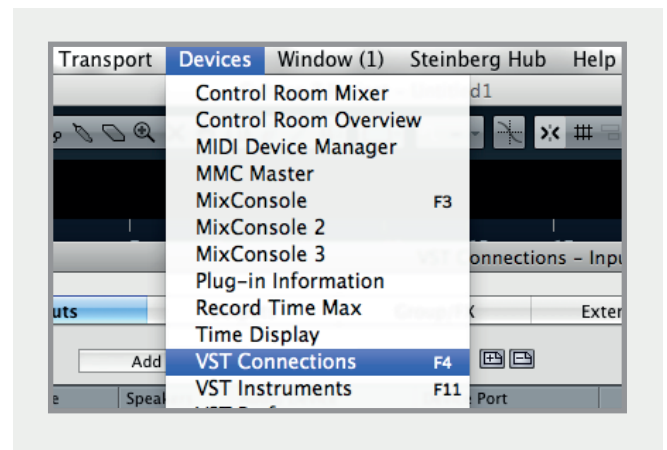

Here you can ensure that all buses have been created in Cubase / Nuendo and therefore all ports are addressable in your session. Add new buses and assign them to the necessary i/o if required.

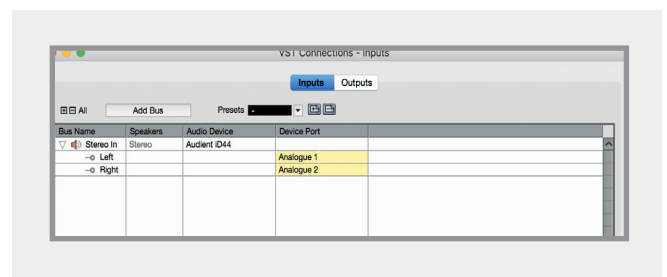

Bus types can be set (mono / stereo) and the VST control room section can also be used. For more information regarding set-up please consult your Steinberg user manuals and documentation.



# Ableton Live Setup

## Operation with Ableton Live

Once iD44 has been successfully installed following the installation process that can be found at the start of this manual, launch Ableton Live and head straight to:

**Live > Preferences > Audio**

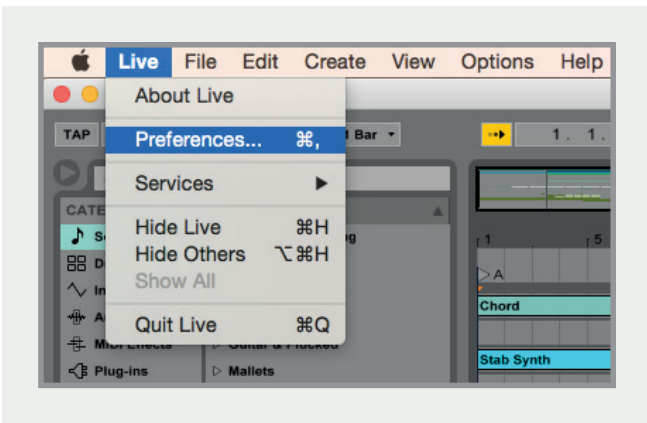

Here navigate to the Audio tab and make sure that iD44 is assigned as the playback device.

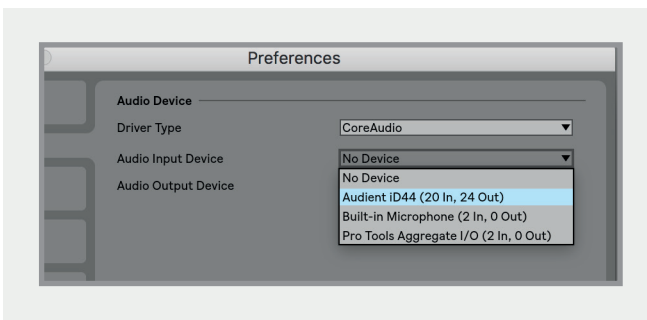

For more information about setting up audio i/o refer to your Ableton Live user manuals & documentation.

In the Live Audio Preference panel you can set an appropriate buffer size (this can be kept high if you are monitoring input signals for recording via the iD mixer. Ensure that iD44 reports as a 20-in, 24-out device to Live.

If necessary you can limit the number of i/o channels reported as active inputs (from the driver) in Live by using the input and output config tabs.

This is an excellent feature to help reduce CPU loading if all channels are not required.

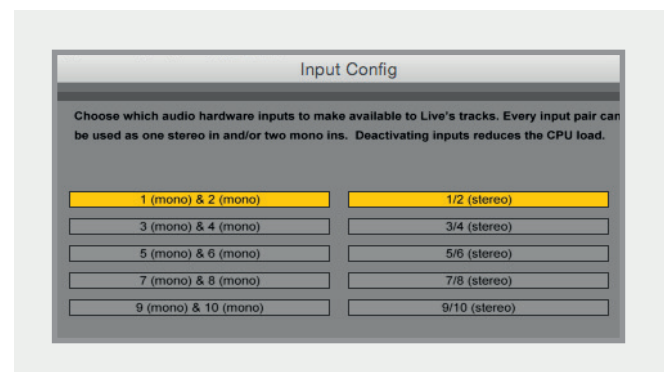
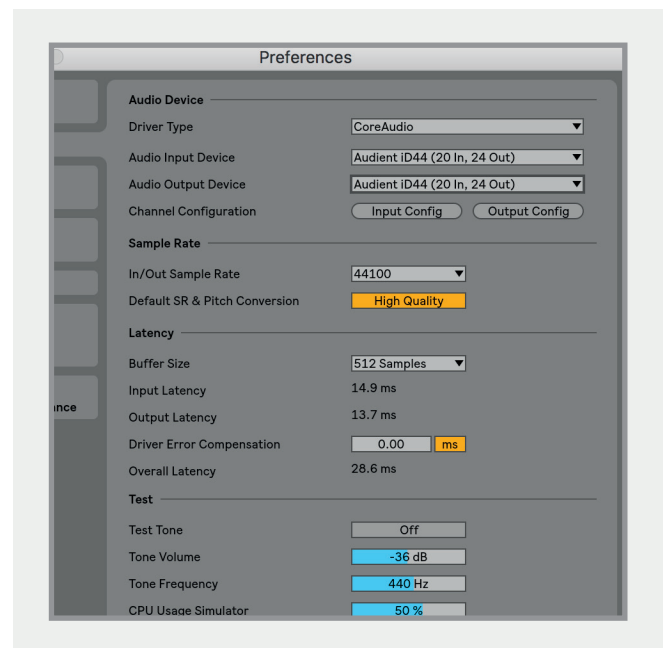

# Troubleshooting & FAQ

## Troubleshooting

### “The unit will not power on”

Double check that the 12V adaptor is properly connected and that the regional adaptor pins of the power supply are fully pushed into place.

### “I get clicks and pops on DAW playback”

This is most likely to do with setting the buffer size too low for your computer. This can be caused by running very large projects with a lot of plugins and virtual instruments. Experiment with higher buffer sizes. Typically you want small buffer sizes for tracking or recording software synths to keep the latency low. However when mixing it is fine to set a slightly higher buffer size as latency is not so much of a problem.

### “When I connect to my computer, I cannot play any audio out from iD44”

Firstly double check that the USB cable connecting iD44 to your computer is functional and attached at both ends.

Double check that iD44 is set as the active playback device in your DAW and computer:

**System Preferences > Sound > Output Tab > Audient iD44 (OSX)**

**Control Panel > Hardware and Sound > Sound > Manage Audio Devices > Audient iD44 (Windows)**

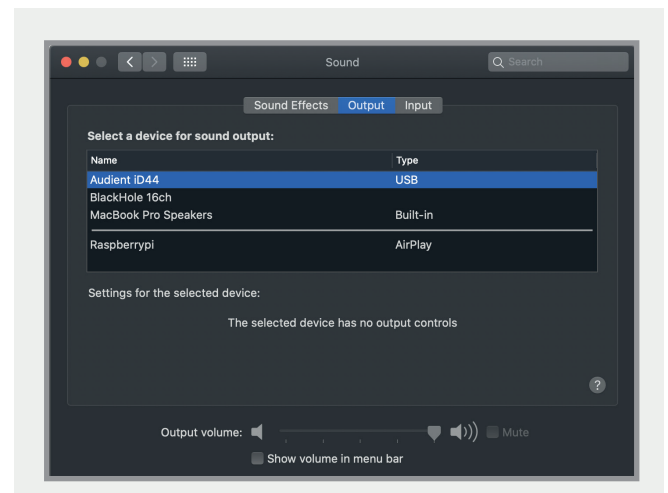

Launch the iD mixer application to activate communication between your computer and iD44. This only needs to be done once straight after power up. Once iD44 is set to the operational state you desire, you can quit the iD application and it will continue to function as intended.

In the software mixer, locate the DAW channels by pressing the DAW view button and increase the level of DAW 1+2 fader.

## Troubleshooting

**“I have clocking issues which include iD44 not locking to external ADAT or SPDIF devices or operating at the incorrect rate compared to my session”**

If there is an issue with syncing of an external device, the Status LED in the System Panel will be red or yellow. If the status light is red then iD44 cannot detect a clock signal from an external device, and yellow if it can detect a signal at the wrong sample rate.

To change sample rate in OSX go to Audio MIDI Setup found by navigating to the folder:

**Macintosh HD > Applications > Utilities > Audio MIDI Setup**

Ensure that Audient iD44 is seen as an audio device (**Window Menu > Show Audio Window**).

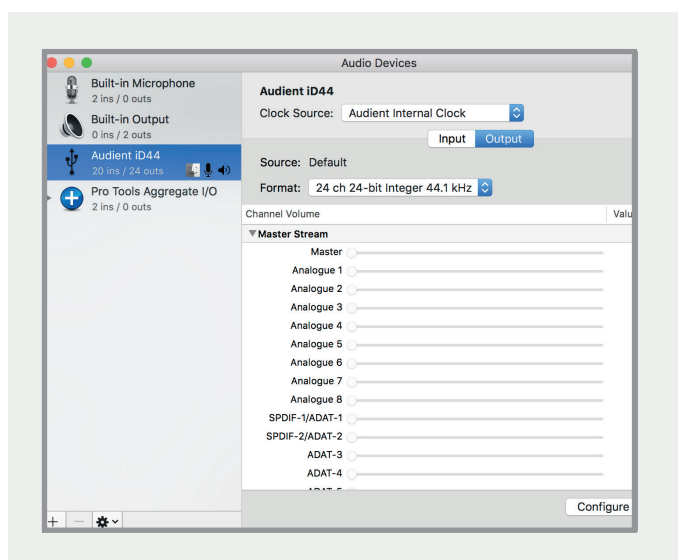

Double check that an appropriate clock source is selected (Internal for master operation), ADAT or S/PDIF clock for external slave operation. Ensure that you see the correct sample rate displayed in the Format drop-down menu.

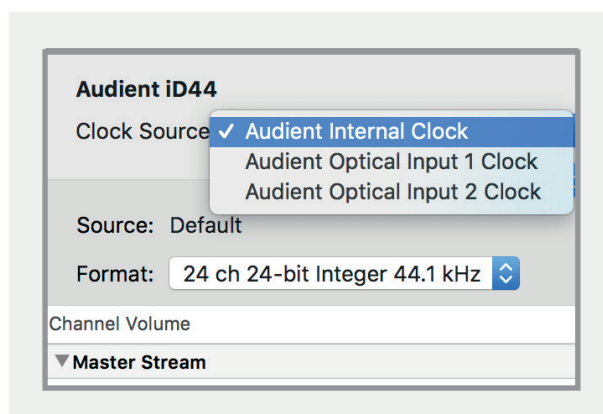

If you are using Windows, go to the iD icon in the system tray and right click on it. This will bring up some settings including sample rate. Alternatively you can alter these settings in the Setup tab of the iD app.

Change the sample rate to match that of the external ADAT device and session.

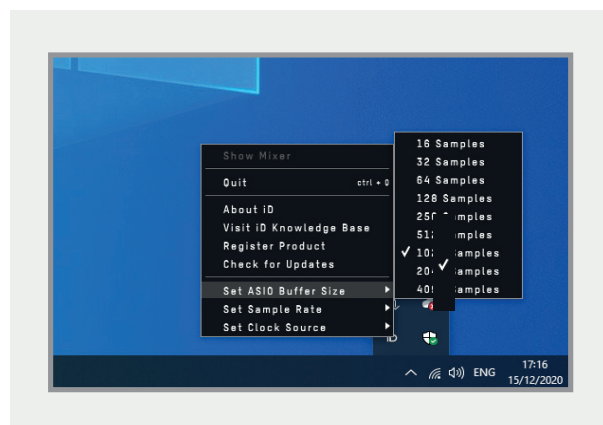

## Troubleshooting

### “How do I reset the iD mixer application to its default state?”

To reset the mixer application, quit the iD app completely, then navigate to the following folder and delete the state.xml file (it will replenish upon a fresh launch of the application):

**Macintosh HD > User > Library > Application Support > Audient > iD > state.xml**

**(C:) > Users > yourusername > AppData > Roaming > Audient > iD > state.xml**

Do not delete the parent folder as this will also contain your iD mixer presets.

### “How do I make sure I have the latest version of iD firmware/software?”

To check for the latest updates to the iD desktop mixer application please visit:

[audient.com/id44/downloads](https://audient.com/id44/downloads)

download and install the latest driver.

You will be made aware of firmware releases from the iD app when connected to the internet. Please refer to earlier in this user manual for more information regarding firmware updates.

## FAQs

For more information and bug support, please search our online Help Centre which can be found here:

[support.audient.com](https://support.audient.com)

For technical support please create a ticket in our online support system, which can also be found in the support section of our website (see link above).

# Technical Specifications



## Microphone Preamplifier:

(Measurement includes ADC signal path)

MIC GAIN:	0 to +60 dB
LINE GAIN:	-10 to +50 dB
PHANTOM POWER:	48v +/-4v @ 10mA/Channel (12VDC only)
MIC EIN	-126.0 dBu
CMRR:	>80dB @ 1kHz
MAXIMUM INPUT LEVEL:	+18 dBu (+28dBu with pad)
INPUT IMPEDANCE (Mic):	3k $\Omega$ balanced
INPUT IMPEDANCE (Line):	10k $\Omega$ balanced
FREQUENCY RESPONSE:	$\pm$ 0.5 dB 10Hz to 65kHz
CROSSTALK:	<-90 dBu @ 1kHz & 10kHz
THD+N @ 0dBu (1kHz):	<0.003% (-96dBu)
SNR:	96 dB
XLR COMBI FEMALE:	Pin 2 (Hot), Pin 3 (Cold) & Pin 1 (Shield)
1/4" TRS JACK:	TIP (Hot), RING (Cold) & SLEEVE (Shield)

## D.I / Instrument Input:

(Channel 1)

D.I GAIN:	0 to 60dB
MAXIMUM INPUT LEVEL:	+10 dBu
INPUT IMPEDANCE:	1Meg $\Omega$ unbalanced
FREQUENCY RESPONSE:	$\pm$ 0.5 dB 10Hz to 50kHz
THD+N @ 0dBu (1kHz):	<0.3%
SNR:	95 dB A-weighted
1/4" JACK:	Tip (Hot) & Sleeve (Shield)

## Analogue to Digital Converter (ADC 1 & 2):

(Measured via Insert Returns under AES-17)

MAXIMUM INPUT LEVEL:	+18 dBu (0 dBFS digital maximum)
DIGITAL REFERENCE LEVEL:	+18 dBu = 0 dBFS
INPUT IMPEDANCE:	>10k $\Omega$ Balanced
FREQUENCY RESPONSE:	$\pm$ 0.5 dB 10Hz to Fs/2 (Nyquist)
CROSSTALK:	-115 dBu @ 1kHz & 10kHz
THD+N @ -1dBFS (1kHz):	<0.0003% (-112dB)
DYNAMIC RANGE:	120 dB A-weighted

1/4" TRS JACK:	TIP (Hot), RING (Cold) & SLEEVE (Shield)
----------------	--

## Digital to Analogue Converter (DAC 1 & 2):

(Measured under AES-17 at line outputs 1 & 2)

MAXIMUM INPUT LEVEL:	+18 dBu (0 dBFS digital maximum)
DIGITAL REFERENCE LEVEL:	+18 dBu = 0 dBFS
OUTPUT IMPEDANCE:	<100 $\Omega$
FREQUENCY RESPONSE:	$\pm$ 0.5 dB 10Hz to Fs/2 (Nyquist)
CROSSTALK:	<-118 dBu @ 1kHz & 10kHz
THD+N @ -1dBFS (1kHz):	<0.0006% (-104dB)
DYNAMIC RANGE:	124 dB un-weighted, 126 dB A-weighted

1/4" TRS JACK:	TIP (Hot), RING (Cold) & SLEEVE (Shield)
----------------	--

## Headphone Outputs

(Measured under AES-17 at phones output)

MAXIMUM OUTPUT LEVEL:	+14 dBu (0 dBFS digital maximum)
DIGITAL REFERENCE LEVEL:	+14 dBu = 0 dBFS
OUTPUT IMPEDANCE:	<50 $\Omega$ unbalanced
FREQUENCY RESPONSE:	$\pm$ 0.5dB 10Hz to Fs/2
CROSSTALK:	<-110 dBu @ 1kHz & 10kHz
THD+N @ -1dBFS (1kHz):	<0.0008% (-103 dB)
DYNAMIC RANGE:	121 dB un-weighted, 124 dB A-weighted
MAX LEVEL INTO 30ohms:	+7.5 dBu 0.003% THD+N Power: 225mW
MAX LEVEL INTO 60ohms:	+10.2 dBu 0.002% THD+N Power: 210mW
MAX LEVEL INTO 600ohms:	+14.2 dBu 0.001% THD+N Power: 54mW
1/4" JACK:	TIP (Hot), RING (Cold) & SLEEVE (Shield)

## USB 2.0 High Speed

No. of INPUT CHANNELS	20 (4 Analogue, 16 Digital)
No. of OUTPUT CHANNELS	24 (8 Analogue, 16 Digital)
CONNECTOR:	USB Type-C
INCLUDED CABLES:	1.5m USB 2.0 Type-C to USB Type-C 1.5m USB 2.0 Type-C to USB Type-A

DSP Mixer Latency:	ROUND TRIP (in-to-out)
	44.1kHz 0.677ms
	48.0kHz 0.625ms
	88.2kHz 0.354ms
	96.0kHz 0.323ms

## Digital Input

16-CHANNEL ADAT:	44.1kHz to 48.0kHz
8-CHANNEL ADAT:	88.2kHz to 96.0kHz SMUX
STEREO S/PDIF:	44.1kHz to 96.0kHz (Stereo)



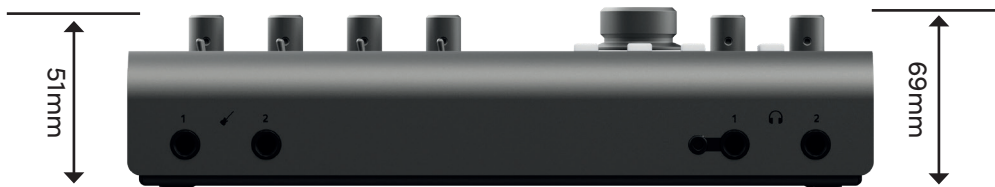
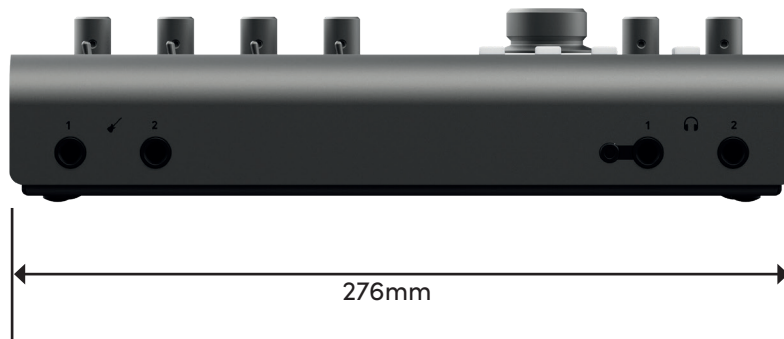

# Warranty

## Warranty Statement

Please read through this Limited Hardware Warranty before using Audient hardware.

Audient products are designed and built to the highest standards, using premium components designed to deliver years of reliable performance.

In the event of a manufacturing defect becoming apparent during the 3 year limited warranty period, Audient will ensure the product is repaired free of charge.

Audient are not liable for direct or consequential loss or damage resulting from the goods and/or their use.

## Warranty Limitations

The Limited Warranty for any product purchased on or after February 01 2021 is for a period of 3 years from the original purchase.

Additionally, the 3-year Limited Warranty is retrospectively offered on any product purchased after February 01 2018.

Without exception you will need to provide a copy of your original dated invoice or store receipt identifying the product serial number as part of the consideration of the grant of warranty.

In the event that you are unable to provide proof of purchase, you should request a copy of your receipt from the reseller from whom you purchased the product.

For the full **'Terms and Conditions'** please head over <https://audient.com/warranty/>

# Service

## Service Information

iD44 contains no user-serviceable components, please refer to qualified service personnel for diagnosis and repair. Your warranty will be void if you tamper with the device at component level. If you have any questions with regard to the repair, please contact Audient Ltd.

If your unit is in warranty, please contact your dealer directly for a repair or replacement (at the discretion of the dealer).

For out of warranty repairs, please contact Audient Ltd, after which a **Return Materials Authorization** (RMA) number will be assigned. This number will serve as a reference for you and helps facilitate and expedite the return process. When the unit is returned please include this RMA number along with a description of the fault inside the packaging box.

To request an RMA, access technical support & FAQs, ask for troubleshooting assistance or make an enquiry, please visit: [support.audient.com](https://support.audient.com)

Audient Ltd  
Aspect House  
Herriard  
Hampshire  
RG25 2PN  
United Kingdom

**Tel: +44 (0) 1256 381944**  
[audient.com](https://audient.com)

# Glossary

A	Amperes
ADAT	Alesis Digital Audio Tape
ADC	Analogue to Digital Converter
DAW	Digital Audio Workstation
ASP	Analogue Signal Processing
CPU	Central Processing Unit
CUE	Artist Headphone Mix
DAC	Digital to Analogue Converter
dB	Decibel
dBu	Decibel referenced to 0.775Vrms = 0 dBu
dBFS	Decibel Full Scale
DC	Direct Current
D.I	Direct Injection (Instrument Input)
DoC	Declaration of Conformity
DSP	Digital Signal Processing
EQ	Equaliser
FAQ	Frequently Asked Questions
FCC	Federal Communications Commission
GB	Gigabyte
GUI	Graphical User Interface
HPF	High Pass Filter
HV	High Voltage
i/o	Input / Output
JFET	Junction Field Effect Transistor
LED	Light Emitting Diode
RoHS	Restriction of Hazardous Substances
RAM	Random Access Memory
S/PDIF	Sony Philips Digital Interface Format
THD+N	Total Harmonic Distortion + Noise
TRS	Tip Ring Sleeve (1/4" Jack Balanced)
TS	Tip Sleeve (1/4" Jack Unbalanced)
USB	Universal Serial Bus
V	Volts
XLR	Extra Live Return, Extremely Low Resistance, Canon X Series, Latching, Resilient Rubber Compound... or make up your own!