



ME 34 | ME 35 | ME 36

Microphone heads for MZH goosenecks



The ME 34, ME 35 and ME 36 are pre-polarized condenser microphone heads for use with the Sennheiser MZH goosenecks. The microphone heads are designed for conference, public address and studio applications.

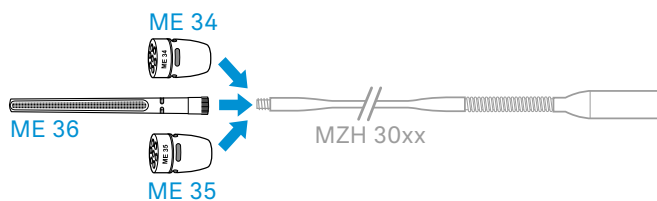

FEATURES

ME 34 | ME 35

- ME 34: cardioid pick-up pattern
- ME 35: super-cardioid pick-up pattern
- Rugged metal housing with non-reflective coating
- High sound quality
- Low equivalent noise level

ME 36

- Super-cardioid/lobar pick-up pattern
- Rugged metall housing with non-reflective coating
- Excellent directivity
- Superior sound quality
- Very low equivalent noise level

DIMENSIONS

ME 34 | ME 35

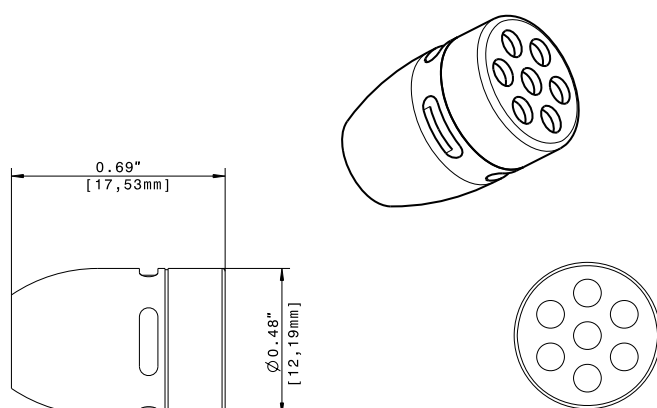

PRODUCT VARIANTS

ME 34	black	Art. no. 005060
ME 34 W	white	Art. no. 005061
ME 35	black	Art. no. 005062
ME 35 W	white	Art. no. 005063
ME 36	black	Art. no. 005064
ME 36 W	white	Art. no. 005065

ACCESSORIES

MZH 3015	Art. no. 005074
MZH 3040	Art. no. 005076
MZH 3042	Art. no. 009384
MZH 3062	Art. no. 500652
MZH 3072	Art. no. 500653
MZH 3015-L	Art. no. 009435
MZH 3040-L	Art. no. 009436
MZH 3042-L	Art. no. 009437
MZH 3062-L	Art. no. 504609
MZH 3072-L	Art. no. 504610

ME 36

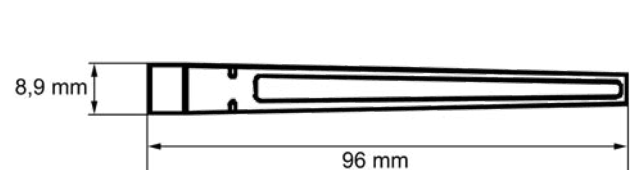



ME 34 | ME 35 | ME 36

Microphone heads for MZH goosenecks

SPECIFICATIONS

	ME 34	ME 35	ME 36
Frequency response	40 – 20000 Hz	50 – 20000 Hz	40 – 20000 Hz
Acoustic operating principle	pressure gradient transducer	pressure gradient transducer	pressure gradient transducer/ interference tube transducer
Pick-up pattern	cardioid	super-cardioid	super-cardioid/lobar
Sensitivity	10 mV/Pa	10 mV/Pa	18 mV/Pa
Electrical impedance	50 Ω	50 Ω	50 Ω
Min. terminating impedance	1 kΩ	1 kΩ	1 kΩ
Equivalent noise level	37 dB (CCIR) 26 dB(A)	37 dB (CCIR) 26 dB(A)	34 dB (CCIR) 23 dB(A)
Power supply via MZH	P12 – P48	P12 – P48	P12 – P48
Current consumption microphone	250 μA	250 μA	250 μA
Dimensions	∅ 12 x 18 mm	∅ 12 x 18 mm	∅ 8.2 x 96 mm
Weight (without MZH)	9.5 g	9.5 g	17 g
Connector	special coax connector	special coax connector	special coax connector

POLAR PATTERN

ME 34

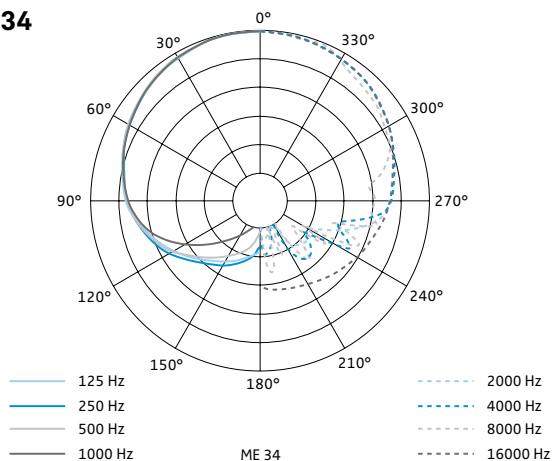

ME 35

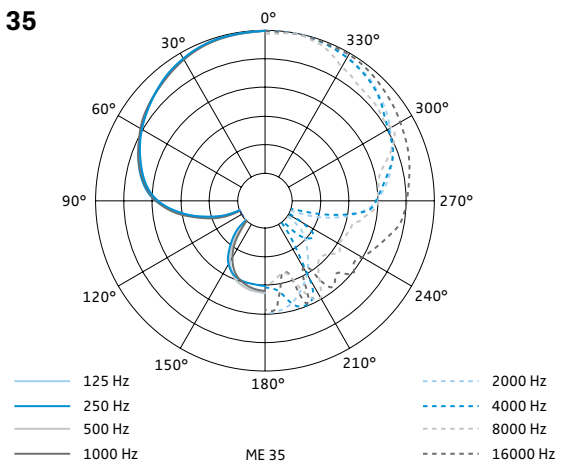

ME 36

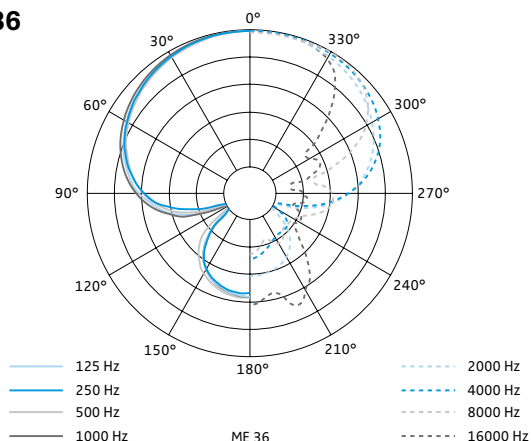



ME 34 | ME 35 | ME 36

Microphone heads for MZH goosenecks

FREQUENCY RESPONSE

ME 34

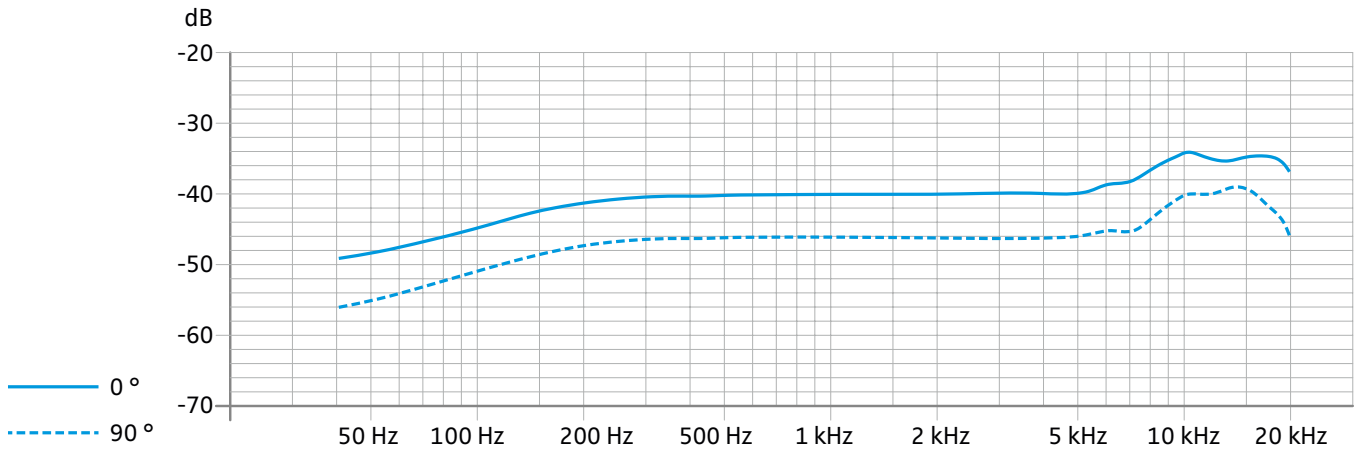

ME 35

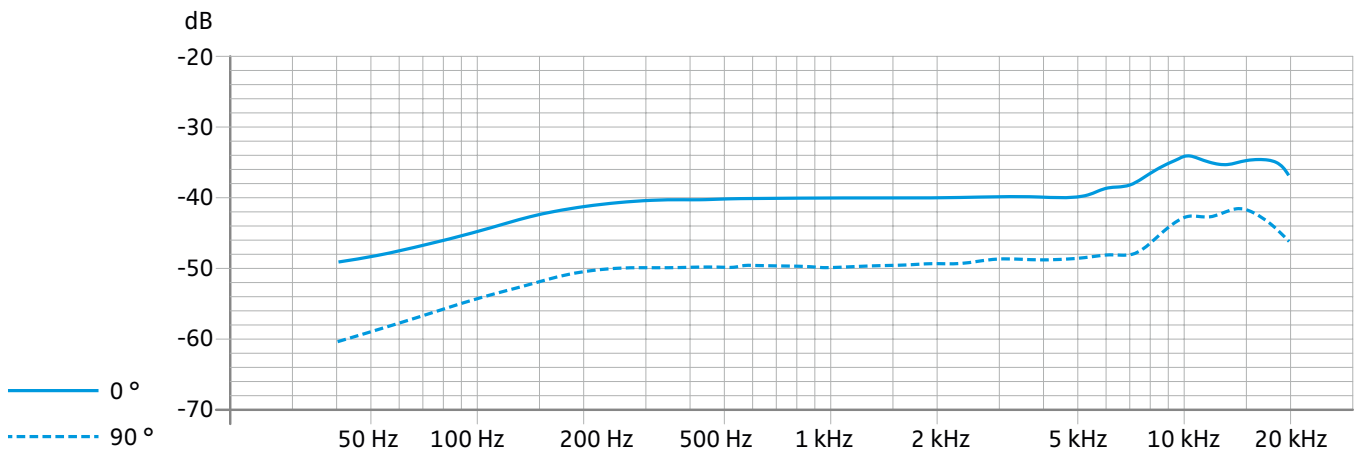

ME 36

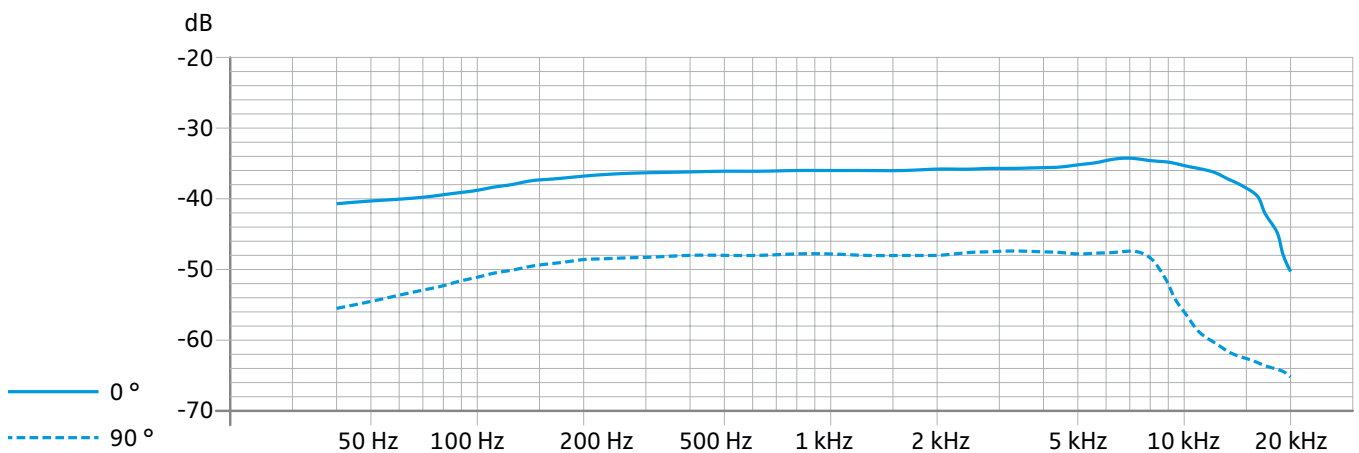



ME 34 | ME 35 | ME 36

Microphone heads for MZH goosenecks

ARCHITECT'S SPECIFICATION

ME 34

A gooseneck microphone for speech transmission shall be modular and streamlined in appearance. The microphone provides a cardioid characteristic and shall be powered with 12 to 48V phantom powering. The microphone shall cover a frequency range of 40Hz to 20kHz, the equivalent noise level must not exceed 26 dB weighted A. For connection with Sennheiser MZH goosenecks a high quality screw thread shall be provided. The electrical contact points shall be gold plated. The housing of the microphone shall be made from metal, finished with a non reflective black coating. Various mounting options and goosenecks shall be available.

The microphone shall be Sennheiser ME34.

ME 35

A gooseneck microphone for speech transmission shall be modular and streamlined in appearance. The microphone provides a supercardioid characteristic and shall be powered with 12 to 48V phantom powering. The microphone shall cover a frequency range of 50Hz to 20kHz, the equivalent noise level must not exceed 26 dB weighted A. For connection with Sennheiser MZH goosenecks a high quality screw thread shall be provided. The electrical contact points shall be gold plated. The housing of the microphone shall be made from metal, finished with a non reflective black coating. Various mounting options and goosenecks shall be available.

The microphone shall be Sennheiser ME 35.

ME 36

A mini shotgun microphone for speech transmission shall be unobtrusive in appearance. The microphone provides a hypercardioid/lobar directivity and shall be powered with 12 to 48V phantom powering. The microphone shall cover a frequency range of 40Hz to 20kHz, the equivalent noise level must not exceed 23 dB weighted A. For connection with Sennheiser MZH goosenecks a high quality screw thread shall be provided. The electrical contact points shall be gold plated. The housing of the microphone shall be made from metal, finished with a non reflective black coating. Various mounting options and goosenecks shall be available.

The microphone shall be Sennheiser ME 36.