

Instruction Manual



All-In-One DJ System

OPUS-QUAD

pioneerdj.com/support/

rekordbox.com

serato.com

For FAQs and other support information for this product, visit the websites above.

Pioneer Dj

serato

Contents

Before you start	7
How to read this manual	7
What's in the box.....	7
User guides	8
Product overview	9
System requirements	9
rekordbox	11
PRO DJ LINK	13
Serato DJ Pro.....	13
PC/Mac setup	14
Setting Utility	17
CloudDirectPlay	20
Using CloudDirectPlay	21
Authentication device for CloudDirectPlay	22
Checking the internet connection	25
Logging in to CloudDirectPlay	26
Playing audio files via CloudDirectPlay	27
Part names	28
Top panel	28
Front panel	29
Rear panel.....	29
Touch screen	31
Connections (basic styles)	42
PRO DJ LINK	42
Connecting storage devices (USB)	46
USB section	46

USB device	47
Track selection.....	48
Browse section	48
Selecting a source.....	49
Selecting a track.....	49
Searching for a track	50
Monitoring sound before loading a track (Touch Preview).....	53
Loading a track to a deck	54
Using History	55
Using the Tag List	56
Displaying the playlist screen	60
Playback	63
Deck section.....	63
Play/pause	64
Playing a track from the touched point on the overall waveform.....	65
Reverse playback.....	65
Adjusting the playback speed (tempo control)	66
Adjusting the playback speed without changing the pitch (Master Tempo)...	66
Monitoring a different part of a track during playback (Touch Cue)	67
Recording.....	68
Splitting a track during recording.....	68
Using the jog wheel	69
Jog wheel section.....	69
Setting the jog wheel mode	70
Jog wheel operations	70
Adjusting the “weight” of the jog wheel	71
Adjusting the playback starting and stopping speeds (for Vinyl mode) ...	71
Cueing.....	72
Setting a cue point	72

Jumping to a cue point	72
Checking a cue point (Cue Point Sampler)	73
Saving a cue point.....	73
Calling up a saved cue point	73
Deleting a saved cue point.....	74
Setting Auto Cue	74
Looping.....	75
Setting a loop	75
Fine-adjusting loop points	76
Adjusting the length of a loop	76
Returning to a loop-in point to start loop playback (Retrigger).....	77
Using Active Loop	77
Canceling loop playback	77
Emergency Loop	78
Saving a loop	78
Calling up a saved loop.....	78
Deleting a saved loop.....	79
Hot Cues	80
Setting a Hot Cue	80
Starting playback from a Hot Cue point	81
Deleting a Hot Cue	81
Calling up Hot Cues	81
Using a Hot Cue Bank.....	82
Beat Jump/Loop Move	84
Using Beat Jump/Loop Move	84
Quantize (for deck)	85
Using Quantize.....	85
Beat Sync	86
Using Beat Sync.....	86

Using Instant Doubles	87
Beatgrid	88
Adjusting the beatgrid	88
Key Sync.....	89
Using Key Sync.....	89
Key Shift	90
Using Key Shift.....	90
Audio output	91
Channel section/master section	91
Outputting sound	93
Adjusting the sound.....	94
Setting the faders	95
Monitoring sound	96
Headphones section	96
Monitoring with headphones	96
Booth section	97
Using a booth monitor	97
Microphone	98
MIC section	98
Using a microphone	99
Reducing the “howling” noise of a microphone (Feedback Reducer) ...	100
ZONE.....	101
ZONE section	101
Using ZONE	102
Sound Color FX.....	103
Sound Color FX section	103
Using Sound Color FX	104
Sound Color FX types and settings.....	105
Beat FX	107

Beat FX section	107
Using Beat FX	108
Setting BPM manually (Tap mode)	110
Using Quantize (for Beat FX)	110
Beat FX types and settings	111
Registering Beat FX to Beat FX Bank	116
Smooth Echo	117
Smooth Echo section	117
Using Smooth Echo	118
Using DJ software	120
Controlling DJ software	120
Settings	122
Changing the settings	122
Utility settings	123
Wireless LAN (Wi-Fi®) connection	129
Bluetooth®/MD connection	131
Changing the settings on the Shortcut screen	133
Setting items on the Shortcut screen	134
Calling up My Settings saved on a storage device (USB)	136
Specifications	137
Additional information	140
Troubleshooting	140
LCD display	142
Trademarks and registered trademarks	143
Cautions on copyrights	144

Before you start

How to read this manual

- Thank you for choosing this Pioneer DJ product.
Be sure to read this manual, the “Quick Start Guide” and the “Precautions for Use” which are also included with this product. These documents include important information that you should understand before using the unit.
- In this manual the names of buttons, knobs and terminals that appear on the product, and the names of buttons, menus etc. in the software on your PC/Mac or mobile device, are indicated within square brackets ([]). (e.g. **[File]**, **[CUE]** button)
- Please note that the software screens and their specifications, as well as the external appearance and specifications of the hardware, are subject to change without notice.
- Please note that depending on the operating system version, web browser settings, etc. operation may differ from the ways described in this manual.
- Please note that the language on the screens of the software described in this manual may differ from the language on your screen.

What's in the box

- Power cord
- Warranty (for some regions)^{*1}
- Quick Start Guide
- Precautions for Use

*1 Only products in Europe.

Products in North America and Japan include warranty information in the “Precautions for Use”.

User guides

❖ rekordbox Introduction, Instruction Manual

Refer to the “rekordbox Introduction” to find out how to set up rekordbox, and see the “Instruction Manual” to find out how to use rekordbox.

Visit the URL below to find these user guides.

rekordbox.com/manual

❖ Serato DJ Pro software manual

Refer to the following Serato DJ site.

serato.com/dj/pro/downloads

Product overview

System requirements

Supported audio sources

This unit supports the following sources.

- USB device
- PC/Mac (page 14)

❖ USB devices

Use USB devices that support the following specifications.

Folder hierarchy	Up to 8 levels (Files in the lower levels can't be played with the unit.)
Maximum number of folders	Unlimited (Up to 10 000 folders in a folder can be displayed.)
Maximum number of files	Unlimited (Up to 10 000 files in a folder can be displayed.)
File format	FAT16, FAT32, exFAT, HFS+ (NTFS isn't supported.)

- The unit can play audio files saved on USB mass storage class devices.
- It may take some time for the unit to read a device when it contains many folders and files.
- Some USB devices may not work properly with this unit.
- The unit doesn't support the following.
 - Optical disc devices such as external DVD/CD drives
 - USB hubs
- We accept no responsibility for loss of data from USB devices, or other direct or indirect problems resulting from connections to this unit.
- If excessive current passes through the USB port on the unit, the unit stops the power supply to the USB device and stops communication. To restore the unit to a normal condition, disconnect the USB device from the unit. Do not use the USB device with the unit again.

If you still can't restore the unit to a normal condition (i.e. if the unit doesn't communicate with a connected USB device), turn the unit off and on.

- If USB devices have multiple partitions, only the first partition can be used (or if there is a partition including rekordbox library, the partition is used instead).
- USB devices with a flash card reader may not work properly with this unit.

Supported file formats

The unit supports audio files in the following formats.

Type	Extension	Format	Bit depth	Bit rate	Sampling frequency
MP3	.mp3	MPEG-1 AUDIO LAYER-3		32 to 320 kbps	
AAC	.m4a, .aac, .mp4	MPEG-4 AAC LC MPEG-2 AAC LC	16bit	16 to 320 kbps	44.1 kHz, 48 kHz
WAV	.wav	WAV			
AIFF	.aif, .aiff	AIFF			44.1 kHz, 48 kHz,
Apple Lossless	.m4a	ALAC	16bit, 24bit	—	88.2 kHz, 96 kHz
FLAC	.flac, .fla	FLAC			

- Some files can't be played with the unit even if they are in a supported format.

Tag information

This unit can read tag information from ID3 tags (v1, v1.1, v2.2.0, v2.3.0, v2.4.0) and meta tags set in audio files.

Artwork of audio files

You can add an artwork image in JPEG format (extensions: “jpg”, “jpeg”) to each audio file. Images larger than 800 x 800 pixels can’t be displayed on this unit.

Display language

If you want to display characters (track names, etc.) in local codes other than Unicode, change the [Language] setting (page 128).

rekordbox

rekordbox is a complete DJ application you can use to manage your music and perform.

- You can use audio files managed in Export mode (the rekordbox music management function) with this unit.
- This unit is a Hardware Unlock device. If you connect a PC/Mac running rekordbox to the unit, you can use Performance mode (rekordbox DJ functions) for free.
- For information on functions supported by Hardware Unlock, visit the URL below.
rekordbox.com
- The rekordbox software isn’t included with the unit. Download the software from the URL below.
rekordbox.com
- For information on the latest system requirements, compatibility, and supported operating systems, visit the URL below.
rekordbox.com/system
- Operation isn’t guaranteed on all PC/Mac models, even if the system requirements are met.
- Depending on power-saving settings and other conditions of your PC/Mac, the CPU and hard disk may not provide sufficient processing capabilities. For laptops in particular, make sure the PC/Mac is in the best condition to provide constant high-level performance when using rekordbox (for example by keeping the AC power connected).

Device Library Plus

Set Device Library Plus for [Library] in [Device] in the [Preferences] window of rekordbox for Mac/Windows.

- For information on Device Library Plus, refer to the FAQ at the URL below.

rekordbox.com/support/faq

Using mobile devices

If you connect mobile devices running rekordbox for iOS/Android to the unit, you can play audio files managed in the app.

- For information on connecting the unit with rekordbox for iOS/Android, refer to the FAQ at the URL below.

iOS:

rekordbox.com/en/support/faq/connecting-to-dj-units/#faq-q100037

Android:

rekordbox.com/en/support/faq/connecting-to-dj-units-android/#faq-q110039

- The DJ performance functions in ver. 4.0.0 or later can't be used with this unit. If you're using ver. 4.0.0 or later, select [Connect to CDJ/XDJ] on the screen below and use the unit with PRO DJ LINK.

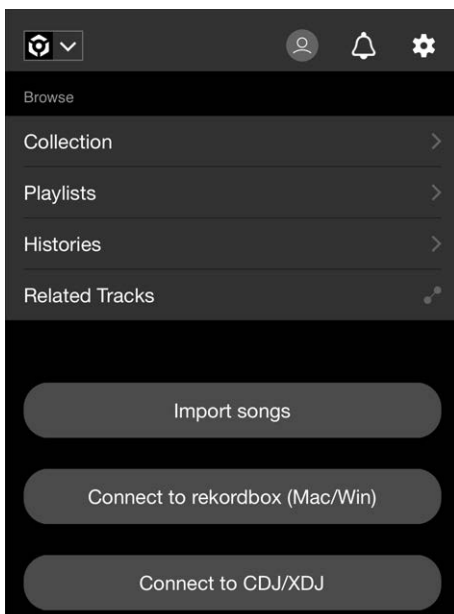

PRO DJ LINK

PRO DJ LINK supports USB Export, which utilizes a storage device (USB device), as well as rekordbox LINK EXPORT, which utilizes a PC/Mac running rekordbox.

➔ Read more: PRO DJ LINK (page 42)

Serato DJ Pro

Serato DJ Pro is DJ software from Serato.

The Serato DJ Pro software isn't included with the unit. Download the software from the URL below.

[serato.com](https://www.serato.com)

- For information on the latest system requirements, compatibility, and supported operating systems, visit the URL below.

[serato.com/dj/pro/downloads](https://www.serato.com/dj/pro/downloads)

- Operation isn't guaranteed on all PC/Mac models, even if the system requirements are met.
- Depending on power-saving settings and other conditions of your PC/Mac, the CPU and hard disk may not provide sufficient processing capabilities. For laptops in particular, make sure the PC/Mac is in the best condition to provide constant high-level performance when using Serato DJ Pro (for example by keeping the AC power connected).

PC/Mac setup

To input your PC's audio to the unit, install the following software on your computer. If you use a Mac, you don't have to install the dedicated audio driver software and rekordbox for Windows USB connection (LINK EXPORT) driver software.

– Dedicated audio driver software:

Driver software used for inputting the PC audio to the unit.

If you install the dedicated audio driver software, Setting Utility will also be installed with the driver software (page 16).

– rekordbox for Windows USB connection (LINK EXPORT) driver software:

Driver software used for connecting a PC running rekordbox to the unit via USB (LINK EXPORT)

For information on the installation, visit the URL below.

pioneerdj.com/support/

- For information on the latest system requirements, compatibility, and supported operating systems, visit the URL below.

pioneerdj.com/support/

- Operation isn't guaranteed on all PC/Mac models, even if the system requirements are met.
- Operation isn't guaranteed when multiple units are connected to a PC/Mac.
- If a PC without the audio driver software installed is connected to the unit, errors may occur on the PC.
- Malfunctions may occur due to incompatibility with other software installed on a PC/Mac.

Installation of the dedicated audio driver software

❖ Notes on installation

- Turn the unit off and disconnect the USB cable connected to the unit and the PC before installation.
- Close all applications running on the PC before installation.
- You'll need admin rights to install the audio driver software to your PC.
- Read the License Agreement terms carefully before installation.
- If you quit the installation halfway through, perform the installation procedure from the beginning again.
- After the installation is complete, connect the PC to the unit.
- Operation isn't guaranteed on all PC models.

Downloading the dedicated audio driver software

1 Visit the URL below.

pioneerdj.com/support/

2 Click [software & firmware updates].

3 Click [OPUS-QUAD] under [ALL-IN-ONE DJ SYSTEM].

4 Click [Drivers].

5 Click [Download link] and save the file.

- Download the audio driver software dedicated to your PC.

Installing the dedicated audio driver software

1 Unzip the downloaded audio driver software.

- Unzip “OPUS-QUAD#####.exe.zip” (# indicates the version number of the software).

2 Double-click the downloaded installation file.

- Double-click “OPUS-QUAD_#.###.exe” (# indicates the version number of the software).

3 Read the License Agreement terms carefully.

If you agree to the terms, mark the [Agree] check box and click [OK].

- If you don't agree to the License Agreement terms, click [**Cancel**] to cancel the installation.

4 Follow the on-screen instructions to complete the installation.

Setting Utility

Once you've installed the driver software on your PC, you can use the Setting Utility for the following.

- Adjusting the buffer size (for Windows ASIO) (page 18)
- Checking the software versions (page 19)

Launching Setting Utility

❖ For Windows 11

- 1 Open the Start menu and click [All Apps] → [Pioneer] → [OPUS-QUAD Setting Utility].

❖ For Windows 10

- 1 Open the Start menu and click [Pioneer] → [OPUS-QUAD Setting Utility].

Adjusting the buffer size (for Windows ASIO)

- Close any running applications (DJ applications, etc.) which use the unit as the default audio device before adjusting the buffer size.

➡ Read more: Launching Setting Utility (page 17)

1 Click the [ASIO] tab.

2 Adjust the buffer size with the slider.

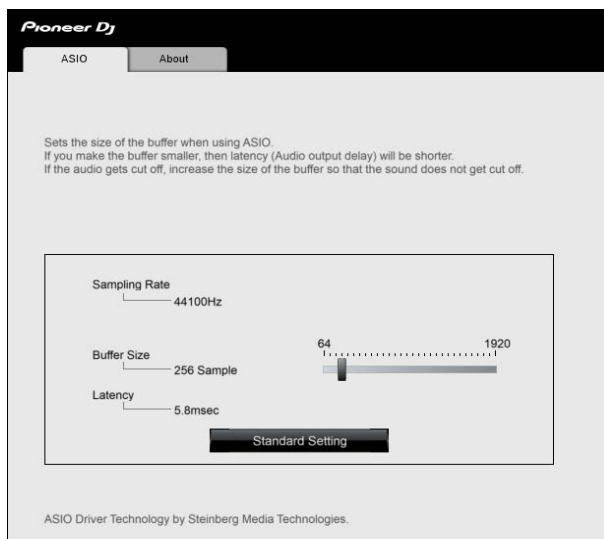

- Breaks in sound are less likely to occur if you set a large buffer size, but this increases lag time due to the latency of audio data transmission.

Checking the software versions

➡ Read more: Launching Setting Utility (page 17)

1 Click the [About] tab.

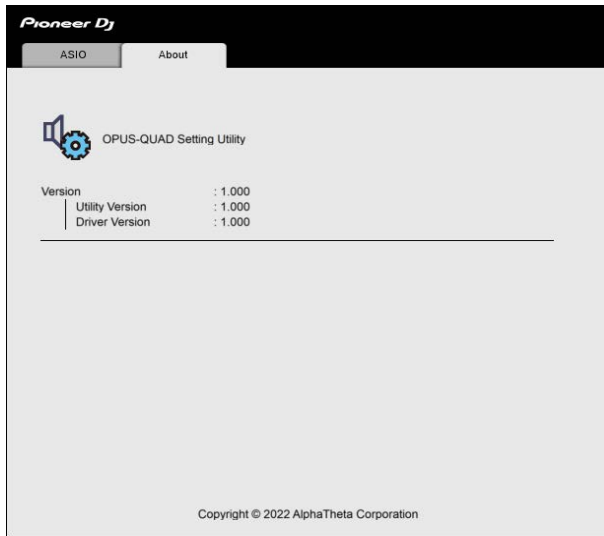

CloudDirectPlay

With CloudDirectPlay, you can load and play audio files you've previously uploaded to your cloud storage onto the unit.

- Use Cloud Library Sync to upload audio files to your cloud storage. You can then play the uploaded files via your PC/Mac, mobile device, or this unit.
- For information on Cloud Library Sync, see the Cloud Library Sync Operation Guide.

rekordbox.com/manual

For information on how to manage audio files uploaded to your cloud storage, refer to the Features page at the URL below.

rekordbox.com

❖ rekordbox version

Install the latest version of rekordbox to use CloudDirectPlay with this unit.

❖ Subscription

You can use CloudDirectPlay with all rekordbox subscription plans, including the Free plan.

- For information on rekordbox plans, see the plan page at the URL below.

rekordbox.com

❖ Cloud storage service

CloudDirectPlay uses the cloud storage service used by Cloud Library Sync.

- Cloud Library Sync and CloudDirectPlay support Dropbox.
- For more information, see the Cloud Library Sync Operation Guide.

rekordbox.com/manual

❖ Transmission speed

The time it takes to sync your library and load audio files via CloudDirectPlay depends on the speed of your internet connection. We recommend a line speed of 20 Mbps or faster for using CloudDirectPlay.

❖ Personal use

With CloudDirectPlay, you can use your rekordbox library on multiple PCs/Macs, mobile devices, and this unit, but you can't share your library with other users.

Using CloudDirectPlay

- 1 Click **[MY PAGE]** at the top right of the screen of rekordbox for Mac/Windows.

The **[MY PAGE]** window opens.

- 2 Click the **[LIBRARY SYNC]** tab.

- 3 Check if **[Sync the library with other devices]** is turned on in **[Cloud Library Sync]**.

- 4 Turn on **[Use rekordbox CloudDirectPlay]**.

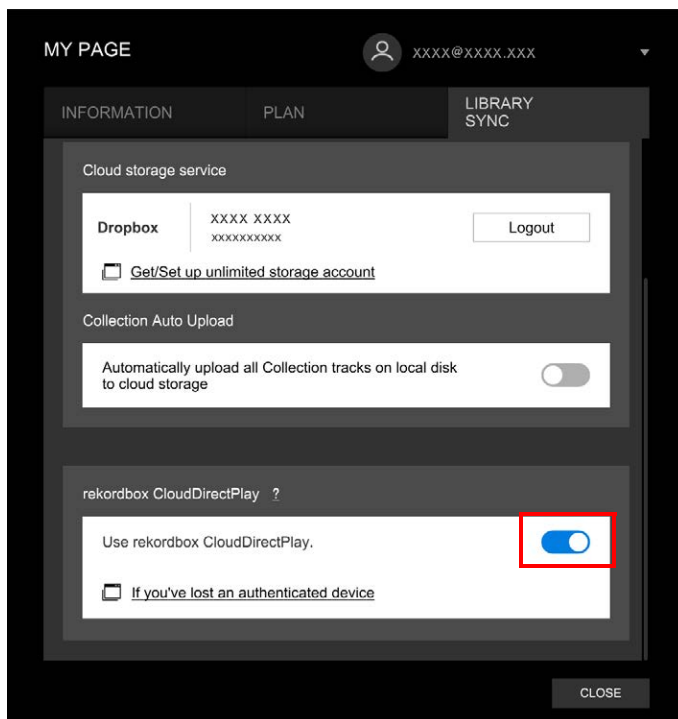

The conversion of the library starts on the cloud server.

After the conversion completes, **[Auth]** (authentication button) is displayed on the right of the device name in the tree view, and you can use CloudDirectPlay.



- Depending on the number of audio files in the library, it may take some time to convert the library.
- If the library conversion fails, **[Use rekordbox CloudDirectPlay]** is automatically turned off. If the conversion error happens repeatedly, contact us for support via the URL below.
rekordbox.com
- If you turn off **[Use rekordbox CloudDirectPlay]**, the authentication for all devices used with the same account is canceled.
- If you turn off **[Use rekordbox CloudDirectPlay]** and turn it on, the library is converted again.

Authentication device for CloudDirectPlay

To play audio files with the unit via CloudDirectPlay, prepare a USB device to use for authentication.

Connect the USB device to your PC/Mac and perform the authentication procedure below.

Authenticating the USB device

- 1 **Connect the USB device to your PC/Mac.**
- 2 **Click  Auth] (authentication button) on the right of the device name in the tree view.**



After the authentication completes,  **Auth]** (authentication button) changes to  (authenticated icon).

Deauthenticating the USB device

- 1 Click  (authenticated icon) on the right of the device name in the tree view.

The USB device is deauthenticated.

- If the USB device has been authenticated with a rekordbox account other than the one you're currently using, perform the procedure with the other account.
- If the USB device has been authenticated with another user's account:
 - Connect the USB device to the PC/Mac of the user who performed the authentication for the device, then deauthenticate it.
 - Access the website from the PC/Mac of the person who performed the authentication for the device, then deauthenticate it (page 23).

Deauthenticating the USB device from the website

You can deauthenticate the USB device from the website, for example, if you lose the device.

- 1 Click **[MY PAGE]** at the top right of the screen of rekordbox for Mac/Windows.

The **[MY PAGE]** window opens.

- 2 Click the **[LIBRARY SYNC]** tab.
- 3 Click **[If you've lost an authenticated device]**.

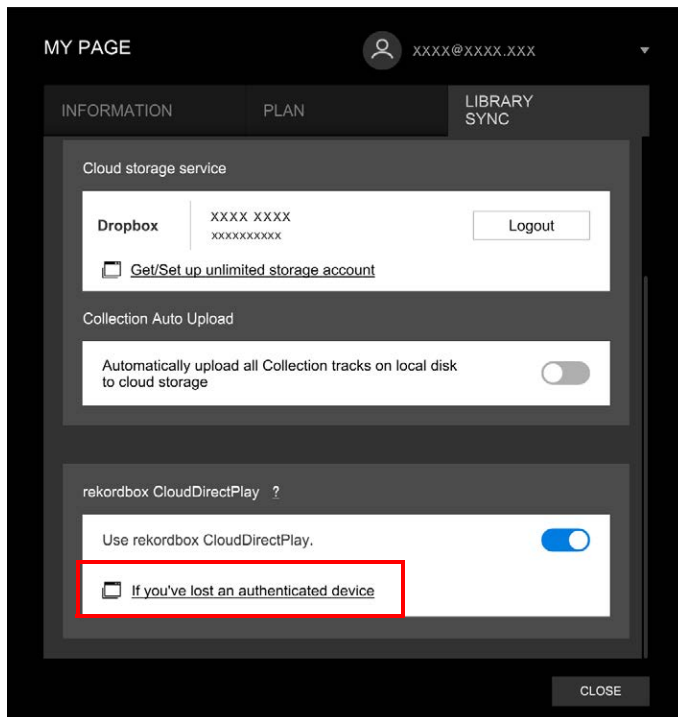

The website is displayed in the browser.

4 Follow the instructions on the website to deauthenticate the device.

- You can't deauthenticate devices authenticated with other accounts. You'll always need to perform the procedure with the account which authenticated the device.

Checking the internet connection

When CloudDirectPlay is available, the internet connection icon is displayed on the [SOURCE] screen of the unit.

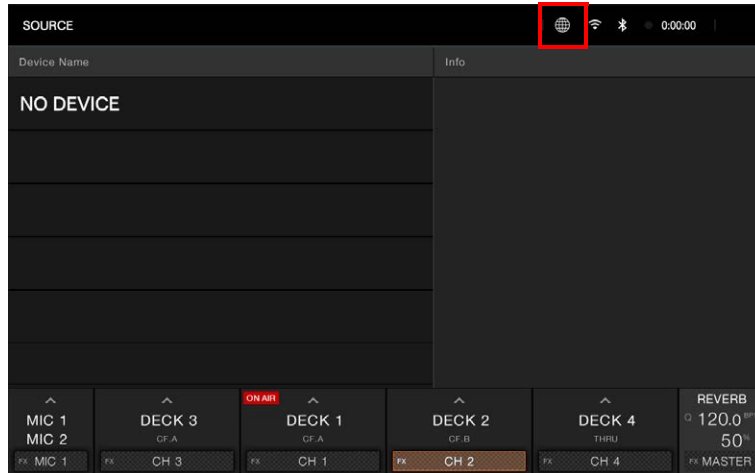

- You can't use CloudDirectPlay when  (gray) is displayed. If this is the case, check the internet connection.

Logging in to CloudDirectPlay

- 1 Connect the authentication USB device for CloudDirectPlay to the unit.

If the connected device is valid, the device name is displayed on the [SOURCE] screen.

- 2 Touch [LOG IN] on the information display for the authentication USB device.

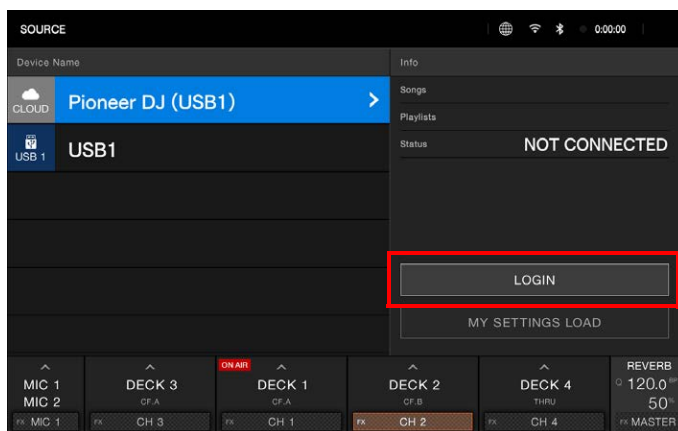

Now you can use CloudDirectPlay.

Logging out of CloudDirectPlay

- 1 On the [SOURCE] screen, touch [LOG OUT] on the information display for the authentication USB device.

Playing audio files via CloudDirectPlay

When CloudDirectPlay is selected on the [**SOURCE**] screen, audio files uploaded to the cloud storage can be played from the browse screen of the unit.

- The time it takes to load audio files depends on the speed of your internet connection. You can view the loading progress in the overall waveform on the waveform screen.
- The following playback functions are only available for audio files loaded from CloudDirectPlay.
 - Memory Cue/Loop
 - Hot Cue/Loop point
- Audio files are loaded one by one from the track list. The following functions aren't available.
 - Track Search
 - [**Continue**] in Play mode
- The following functions aren't available for CloudDirectPlay.
 - Touch Preview
 - Hot Cue Bank list
 - Intelligent playlist
- While using CloudDirectPlay, any track information changed by other CloudDirectPlay or Cloud Library Sync devices used with the same account isn't reflected until you log out of CloudDirectPlay and log in again.

Part names

Top panel

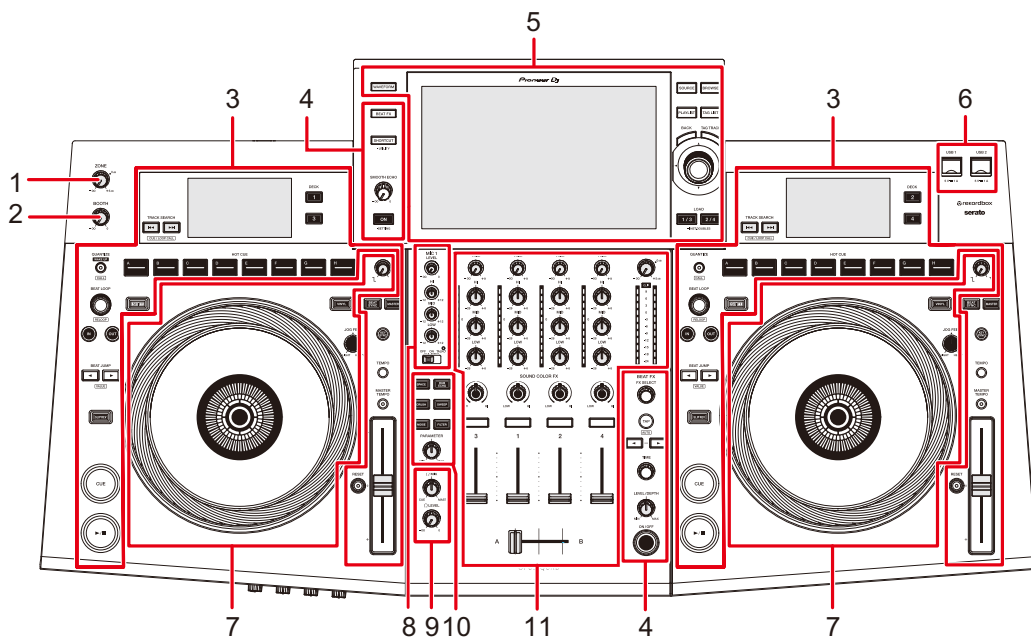

1. **ZONE level knob** (page 101)
2. **BOOTH level knob** (page 97)
3. **Deck section** (page 63)
4. **Beat FX/SMOOTH ECHO section** (pages 107, 117)
5. **Browse section, Touch screen** (pages 31, 48)
6. **USB section** (page 46)
7. **Jog wheel section** (page 69)
8. **MIC section** (page 98)
9. **Headphones section** (page 96)
10. **Sound Color FX section** (page 103)
11. **Channel section/Master section** (page 91)

Front panel

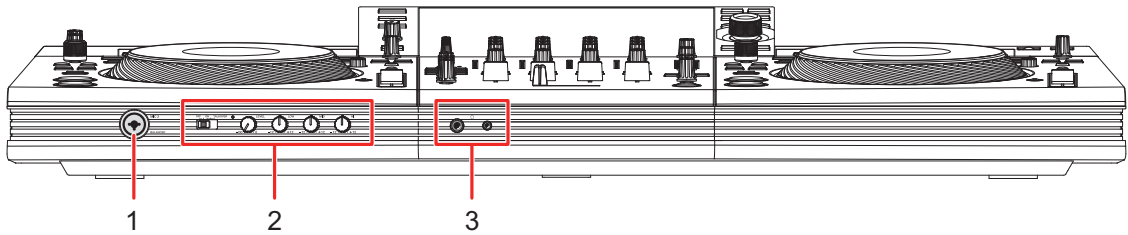

1. **MIC 2 terminal (XLR or 1/4"/6.35 mm, TRS)** (page 99)
2. **MIC section** (page 98)
3. **PHONES terminals** (page 96)

Connect headphones to one of the terminals (1/4" stereo jack or 3.5 mm stereo mini jack). Using both terminals at the same time may lower the sound quality or volume level.

Rear panel

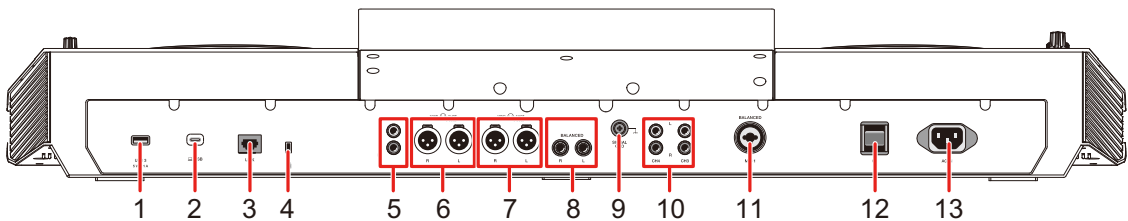

1. **USB 3 port** (page 46)
 - If using a USB cable, use a 2 m or shorter cable.
2. **USB port** (page 43)

Connect a PC/Mac.

 - Use a 2 m or shorter USB cable.
3. **LINK terminal** (page 44)

Connect to a LAN terminal on a PC/Mac running rekordbox.

 - For wired LAN connections, use a Cat5e (or higher) STP cable.
4. **Kensington security slot**

Connect a cable lock.
5. **MASTER 2 terminals (RCA)**

Connect to analog input terminals on a power amplifier, etc.

6. **MASTER 1 terminals (balanced XLR)**

Connect to analog input terminals on a power amplifier and powered speakers, etc.

- Use the terminals for balanced output only. Connecting the terminals to unbalanced inputs (RCA, etc.) with an XLR-RCA conversion cable (conversion adapter), etc. results in unwanted noises and/or poor sound quality.
- Do not connect a power cord from another product to the terminals.
- Do not connect to a terminal that can supply phantom power.
- Use the [**MASTER 2**] terminals for unbalanced input (RCA, etc.).

7. **ZONE terminals (balanced XLR)** (page 101)

Use these output terminals for the ZONE channel.

- Use the terminals for balanced output only. Connecting the terminals to unbalanced inputs results in unwanted noises and/or poor sound quality.

8. **BOOTH terminals (1/4"/6.35 mm, TRS)** (page 97)

Connect a booth monitor.

- Use the terminals for balanced output only. Connecting the terminals to unbalanced inputs results in unwanted noises and/or poor sound quality.

9. **Signal GND terminal**

Connect a turntable's ground wire.

Reduces unwanted noises that occur when a turntable is connected to the unit.

10. **LINE/PHONO terminals (RCA)**

Connect multi players, line-level output devices, or phono-level (MM cartridge) output devices.

- A loud volume may be output depending on the input signal. Make sure that the input signal matches the settings.

11. **MIC 1 terminal (XLR or 1/4"/6.35 mm, TRS)** (page 99)

12. **⏻ button**

Turns the unit on or puts it in standby mode.

13. **AC IN**

Connect to a power outlet with the supplied power cord.

Touch screen

SOURCE screen

Press the [SOURCE] button to display the source selection screen.

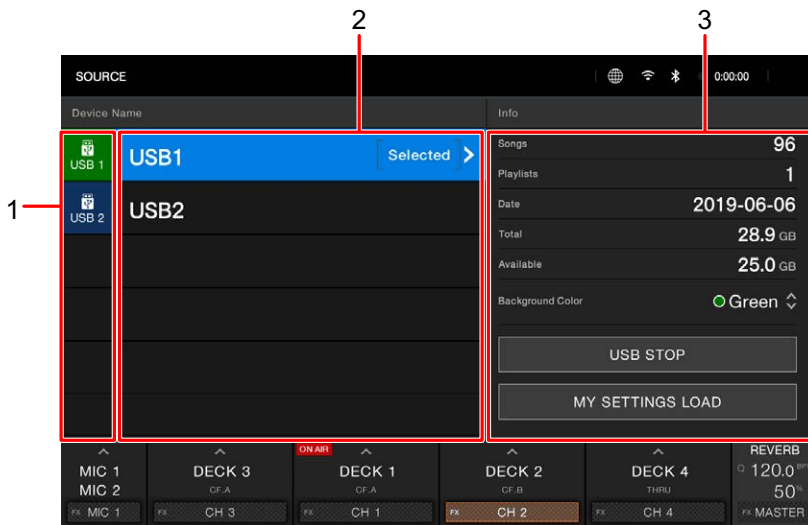

1. Device icon

Displays the connected device.

- If [Background Color] is set for the device, the icon's background is displayed in the chosen color.

2. Device name/status

Displays the device name and status.

3. Device information

Displays the information for the highlighted device in the list.

- You can set the following when a storage device (USB) is selected in the list.
 - [MY SETTINGS LOAD]: Calls up the Utility settings and some other settings saved on the storage device (USB). You can also call up My Settings from the [SHORTCUT] screen (page 136).
 - [Background Color]: Sets the icon's background color (for storage devices (USB) containing audio files or management data exported from rekordbox). This setting is also applied to colors for a part of the touch screen.

Browse screen

Press the **[BROWSE]**, **[TAG LIST]**, or **[PLAYLIST]** button to display the browse screen (track list).

You can browse the rekordbox library on a storage device (USB), via CloudDirectPlay, or on a connected PC/Mac.

- If you browse a storage device (USB) that doesn't contain a rekordbox library on the **[BROWSE]** screen, the folder and track lists are displayed in a hierarchical structure.

When you press the **[BROWSE]** button

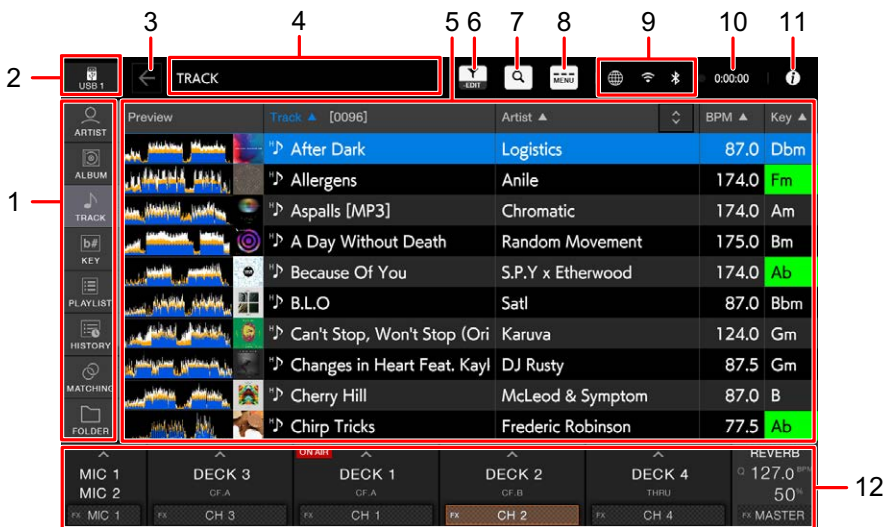

1. **Category**

Displays the categories.

- Go to **[Preferences]** in rekordbox to choose the categories you want to display.

2. **Device icon**

Displays the icon of a device selected on the **[SOURCE]** screen (page 31).

3. **← (Back)**







Displays the next level up.

4. **Next level up display**

Displays the folder or device name in the next level up.

5. **Track list**

Displays the Preview waveform, artwork, and the track list of the selected hierarchical level or playlist.

- Touch the waveform in the **[PREVIEW]** column to monitor the sound before loading a track (page 53).
 - Touch the title row to sort the list.
 - Touch  on the title row to display the sub-column selection screen and select a sub-column to be displayed. (To set sub-columns you want to display in the selection list, go to **[Preferences]** in rekordbox.)
6.  **(Track Filter/EDIT)**
Narrows down tracks by Track Filter (page 52).
 7.  **(Search)**
Displays the **[SEARCH]** screen (page 50).
 8. **MENU**
Displays **[MENU]** on the mixer information display.
 9. **Connection status icons**
 -  (Internet connection icon): Displays the status of the internet connection.
 -  (Wi-Fi connection icon): Displays the status of the Wi-Fi connection.
 -  (Bluetooth connection icon): Displays the status of the Bluetooth connection.
 10. **Rec timer**
Displays the recording time when using Master Rec (page 68).
 11.  **(Information)**
Touch to display or hide the detailed information for the track highlighted in the list.
 12. **Mixer information display**
Displays the information for MIC, channels, and effects, etc.

Playback screen (waveform screen)

❖ Main display

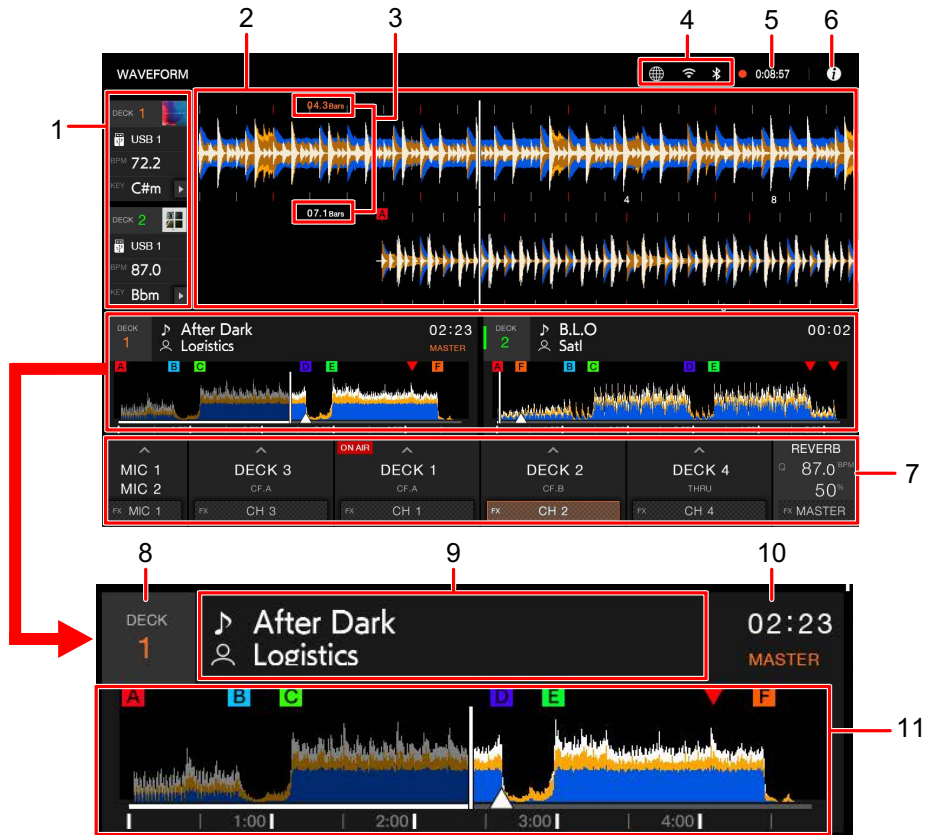

1. Deck information

Displays the following information for the loaded track.

- Device: Displays where the track is saved.
- Artwork: Displays the artwork.
- BPM (for deck): Displays the BPM (beats per minute, i.e. tempo) of the track being played. The measured value may differ from that measured by our DJ mixers due to differences in the measurement methods. This isn't a malfunction.
- Key: Displays the key of the track.
-  (Key Shift) (page 90)

2. Enlarged waveform



Displays the enlarged waveform, cue points, loop points, and Hot Cue points, etc. that have been analyzed by rekordbox.

- In Zoom mode: Zooms in and out of the waveforms on the screen at the same time.
- In Grid Adjust mode: Adjusts the beatgrid of the track loaded to the active deck (page 88).
- You can change the waveform color in **[MY SETTINGS LOAD]** on the **[SOURCE]** screen or **[Waveform Color]** on the **[SHORTCUT]** screen (page 134).

3. **Beat countdown**

Displays the number of bars and beats from the playback point to the closest saved cue point.

4. **Connection status icons**

-  (Internet connection icon): Displays the status of the internet connection.
-  (Wi-Fi connection icon): Displays the status of the Wi-Fi connection.
-  (Bluetooth connection icon): Displays the status of the Bluetooth connection.

5. **Rec timer** (page 68)

Displays the recording time when using Master Rec.

6. **(Information)**

Touch to display or hide the detailed information for the track loaded on the deck.

7. **Mixer information display**

- MIC information area (page 98)
- Channel information area (page 91)
- **[ON AIR]**: Displayed when the sound can be output from **[MASTER 1]** or **[MASTER 2]** terminals.
- BEAT FX information area (page 107)
 - Displays the selected Beat FX (effect name) (page 111).
 - Displays the BPM (beats per minute, i.e. tempo) for Beat FX.
In Auto mode, the automatically detected BPM is displayed. In Manual Setting mode, the BPM is displayed in green and **[TAP]** is displayed.
 - Displays **[Q]** in white when Quantize for Beat FX is turned on and active, and in gray when it's turned on but not active (page 110).
 - Displays the parameters (beat, %, msec) set for the effect.

8. **Deck number**

9. **Track name/artist**

Displays the track name and artist for the loaded track.

- Only the track name is displayed when **[Overall Waveform Display]** is set for **[4deck]** (page 127).

10. Time display (minutes, seconds, msec)

Displays remaining time or elapsed time.

- You can set the time display (remaining time or elapsed time) in **[Time Mode]** on the **[SHORTCUT]** screen (page 134).

11. Overall waveform

Displays the overall waveform, cue points, loop points, and Hot Cue points, etc. that have been analyzed by rekordbox.

You can start playback from a point you touch on the waveform (page 65).

- The indicators on the overall waveform indicate the following.
 - Playing address: Shows the track as a bar graph (horizontal line). The current playback point is indicated with a white vertical line on the bar graph. When the time display is set to **[TIME]**, the graph lights up from the start of the track up to the playback point to indicate elapsed time. When the time display is set to **[REMAIN]**, the graph goes dark to the left of the playback point, so the remaining part of the track stays lit up.
 - Scale display (30-second interval)/phrase meter: Displays scales at 30-second intervals or displays the phrase meter below the playing address. You can set the display (scale or phrase meter) in **[Waveform Divisions]** of the Utility settings (page 127).
 - Saved cue/loop points, Hot Cue/Loop points: Indicates cue/loop points and Hot Cue/Loop points saved in the track with marks above the waveform.
 - Cue/loop points: Indicates cue/loop points set in the track with marks below the waveform.
 - Countdown display: Displays the saved cue point that's set as the countdown target.
- You can change the waveform color in **[MY SETTINGS LOAD]** on the **[SOURCE]** screen or **[Waveform Color]** on the **[SHORTCUT]** screen (page 134).
- You can set different colors for saved cue/loop points and Hot Cue/Loop points in rekordbox.

❖ Deck display

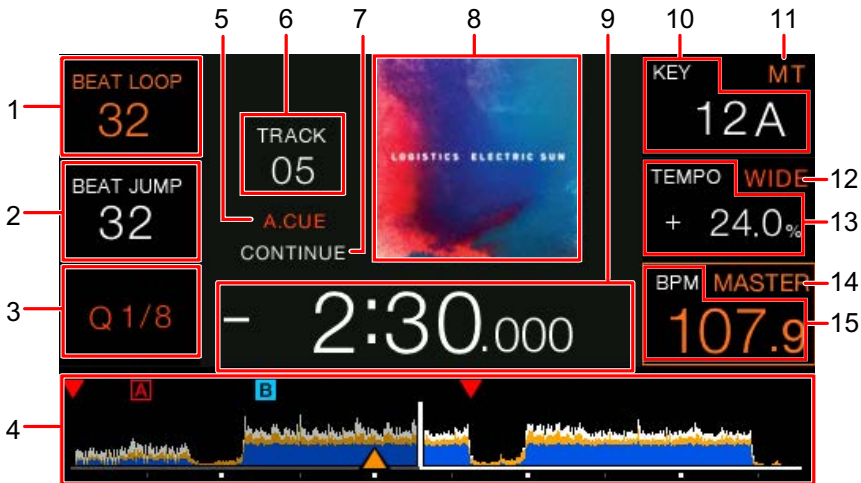

1. Number of beats for a loop

Displays the number of beats set for a beat loop or a loop playing.

2. Number of beats for Beat Jump

Displays the number of beats set for a Beat Jump.

3. Q (Quantize for deck) display, number of beats for Quantize (page 85)

Displayed in red when Quantize for that deck is turned on and active, and in gray when it's turned on but not active.

- Set the number of beats in [Quantize Beat Value (Deck)] in the Utility settings or [Quantize Beat Value] on the [SHORTCUT] screen (pages 123, 134).

4. Overall waveform

Displays the overall waveform, cue points, loop points, and Hot Cue points, etc. that have been analyzed by rekordbox.

- The indicators on the overall waveform indicate the following.
 - Playing address: Shows the track as a bar graph (horizontal line). The current playback point is indicated with a white vertical line on the bar graph. When the time display is set to [TIME], the graph lights up from the start of the track up to the playback point to indicate elapsed time. When the time display is set to [REMAIN], the graph goes dark to the left of the playback point, so the remaining part of the track stays lit up. The graph blinks when the remaining time becomes less than 30 seconds, and blinks quicker when it becomes less than 15 seconds.
 - Scale display (30-second interval): Displays scales at 30-second intervals below the playing address.

- Saved cue/loop points, Hot Cue/Loop points: Indicates cue/loop points and Hot Cue/Loop points saved in the track with marks above the waveform.
 - Cue/loop points: Indicates cue/loop points set in the track with marks below the waveform.
 - You can change the waveform color in [**MY SETTINGS LOAD**] on the [**SOURCE**] screen or [**Waveform Color**] on the [**SHORTCUT**] screen (page 134).
 - You can set different colors for saved cue/loop points and Hot Cue/Loop points in rekordbox.
5. **A.CUE indicator** (page 74)
Displayed when the Auto Cue is turned on.
 6. **Track number**
Displays the number (01-999) of the loaded track.
 7. **Play mode indicator**
Displays playback mode for the loaded track.
 - Set the playback mode in [**Play Mode**] in the Utility settings (page 124).
 8. **Artwork**
 9. **Time display (minutes, seconds, msec)**
Displays remaining time or elapsed time.
 - You can set the time display (remaining time or elapsed time) in [**Time Mode**] on the [**SHORTCUT**] screen (page 134).
 10. **Key**
Displays the key of the track.
 11. **MT indicator**
Displayed when Master Tempo is turned on.
 12. **Playback speed adjustment range**
Displays the adjustable range from the original playback speed (page 66).
 13. **Playback speed**
Displays the playback speed set by the TEMPO slider.
 14. **MASTER indicator**
Displayed when the unit is set as the sync master.
 15. **BPM**
Displays BPM (beats per minute, i.e. tempo) for the track playing.
 - The measured value may differ from that measured by our DJ mixers due to differences in the measurement methods. This isn't a malfunction.

Jog display

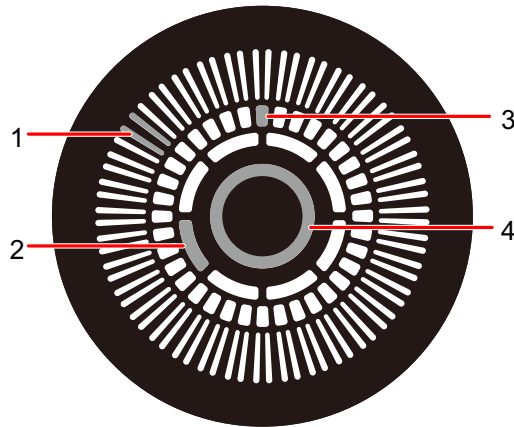





- 1. Playback point indicator**
Indicates the playback point (turns during playback and stops when the track is paused).
- 2. Jog wheel touch detection indicator**
Lights up when the top of the jog wheel is pressed with Vinyl mode turned on.
- 3. Cue/loop/Hot Cue point indicator**
Indicates cue points, loop points, or Hot Cue points.
- 4. Cue point color**
Displays the color set for cue points.

Basic operations on the touch screen

Use the smart rotary selector or touch the screen to operate it.

❖ Using the smart rotary selector

The following functions are available.

Operation		Description
Tilt left or right		Tilt left or right when the waveform is displayed on the browse screen to monitor the sound before loading the track.
Tilt up or down		Tilt up or down when a hierarchy is displayed on the browse screen to scroll through the next level down without moving the hierarchy.
Rotate		Moves the cursor and highlights an item.
Press		Selects the highlighted item.

❖ Touch operations

Operation		Description
Touch	Other than waveform	<p>Selects the highlighted item.</p> <ul style="list-style-type: none"> • Touch an item (e.g. a folder) in a hierarchy to display the next level down. • Touch a track to display the track menu.
	Waveform	Touch the overall waveform on the browse screen to monitor the sound from the touched point.
Flick		Scrolls up or down in the hierarchy.

❖ Returning to the next level up

1 Press the **[BACK]** button on the top panel.

The next level up (previous screen) is displayed.

- Press and hold the **[BACK]** button to highlight the top level in the hierarchy.

Connections (basic styles)

Turn the unit off and disconnect the power cord before connecting other units.

Connect the power cord after all the connections are complete.

- Use the supplied power cord.
- Read the instruction manuals for the devices you are going to connect with the unit.

PRO DJ LINK

USB Export

You can transfer audio files and management data of rekordbox for use on this unit using a storage device (USB). You can play playlists or tracks with cues, loops, and Hot Cues previously set in rekordbox.

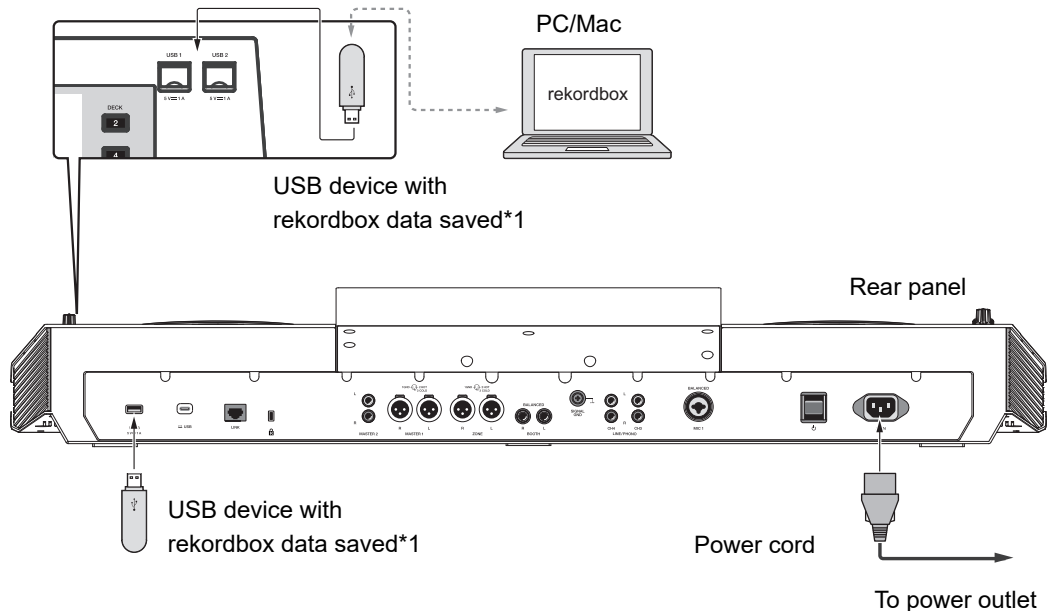

*1 If using a USB cable, use a 2 m or shorter cable.

rekordbox LINK EXPORT

You can directly select and play tracks in rekordbox with this unit when the unit is connected via a LAN cable (CAT5e), a USB cable, or wireless LAN (Wi-Fi) to a PC/Mac running rekordbox. You can play playlists or tracks with cues, loops, and Hot Cues previously set in rekordbox.

- Install the rekordbox for Windows USB connection (LINK EXPORT) driver software before connecting the unit to a PC with a USB cable (page 14).
- For information on the connection with rekordbox for iOS/Android, refer to the FAQ at the URL below.

iOS:

rekordbox.com/en/support/faq/connecting-to-dj-units/#faq-q100037

Android:

rekordbox.com/en/support/faq/connecting-to-dj-units-android/#faq-q110039

❖ When using a USB cable

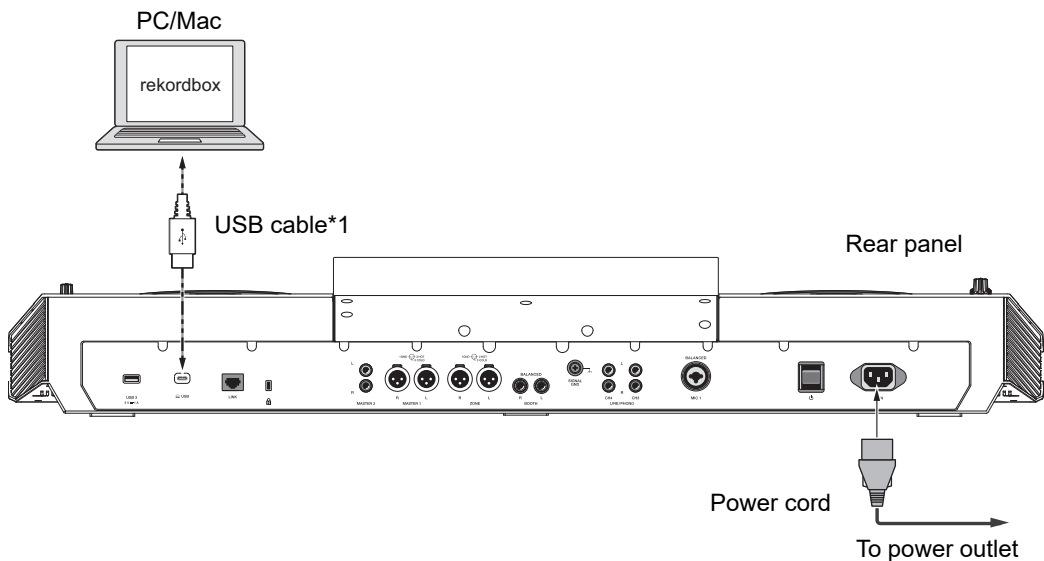

*1 Use a 2 m or shorter USB cable.

- Insert or pull a USB cable straight into/out of the USB port on the rear panel. Be careful not to apply force in a vertical or horizontal direction.

❖ When using a LAN cable

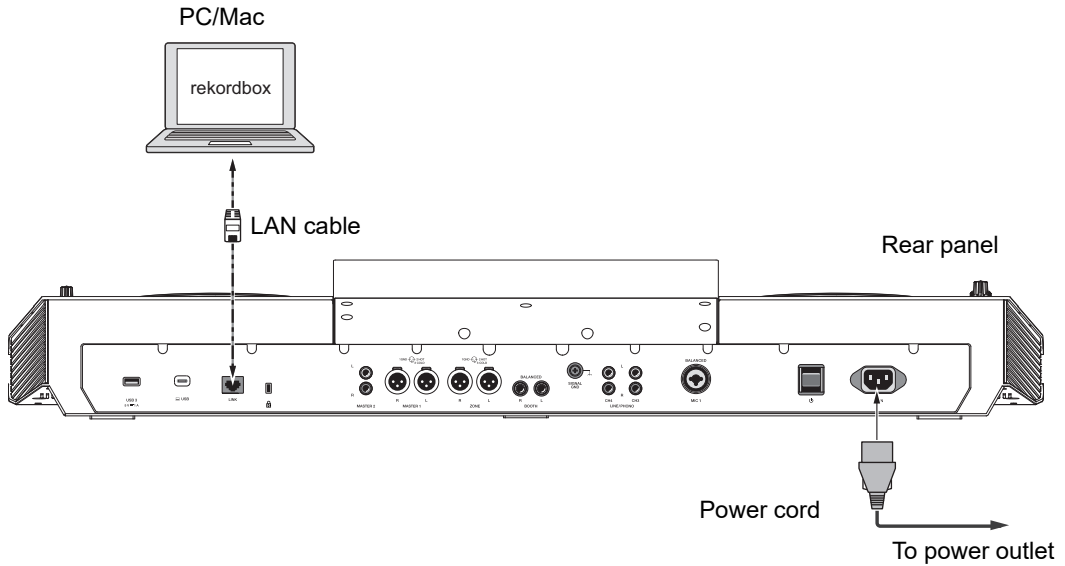

❖ When using a wireless LAN router and an access point

Using a LAN cable:

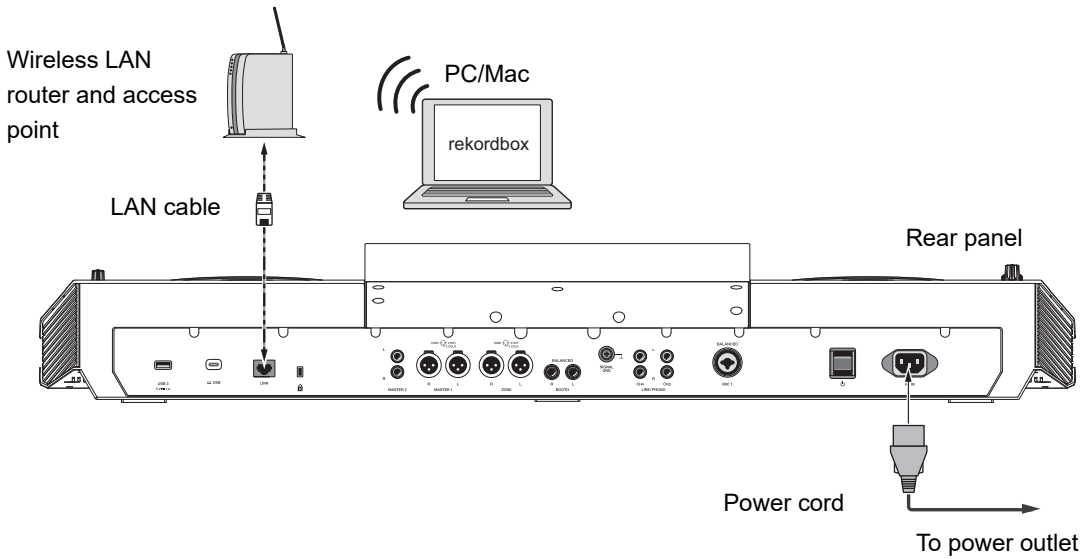

Connections (basic styles)

Using the internal wireless connection (Wi-Fi):

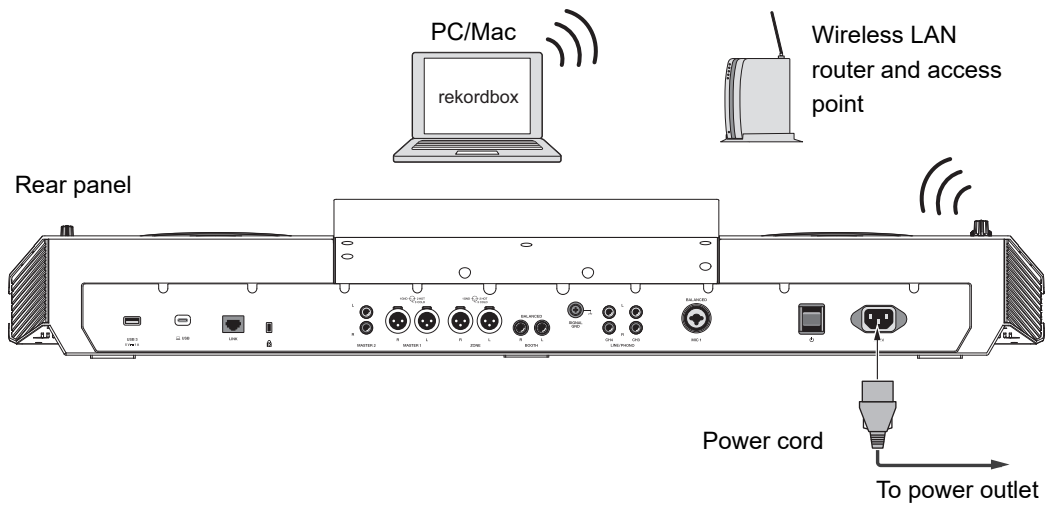

- To use CloudDirectPlay, connect PRO DJ LINK (wireless LAN router) to the internet.

Connecting storage devices (USB)

USB section

Top panel:

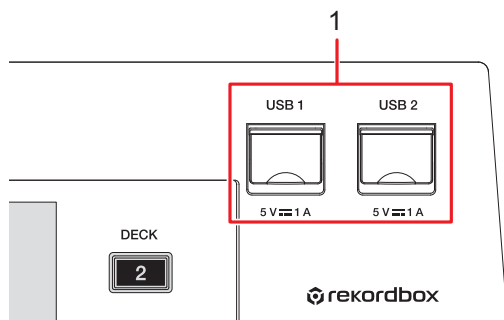

Rear panel:

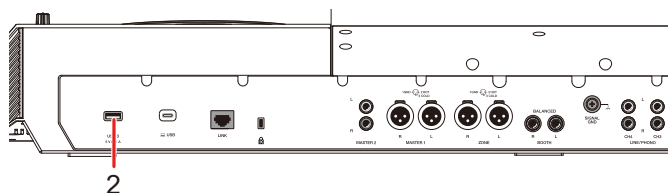

1. **USB 1, USB 2 ports**
2. **USB 3 port**

USB device

- Do not disconnect a USB device from the unit without using [**USB STOP**] and do not turn the unit off when a USB device is connected, otherwise the unit's management data may be deleted or the USB device may become unreadable.
- Be careful not to press or pull the USB port cover with excessive force, or it may be damaged.

Connecting a USB device

- 1 Insert a USB device at a straight angle until it stops.

Disconnecting a USB device

- 1 Press the [**SOURCE**] button.

Devices connected to the unit are displayed on the [**SOURCE**] screen (page 31).

- 2 Select the device to disconnect from the unit, and touch [**USB STOP**].
- 3 After it disappears from the list, pull the USB device out at a straight angle.

Track selection

Browse section

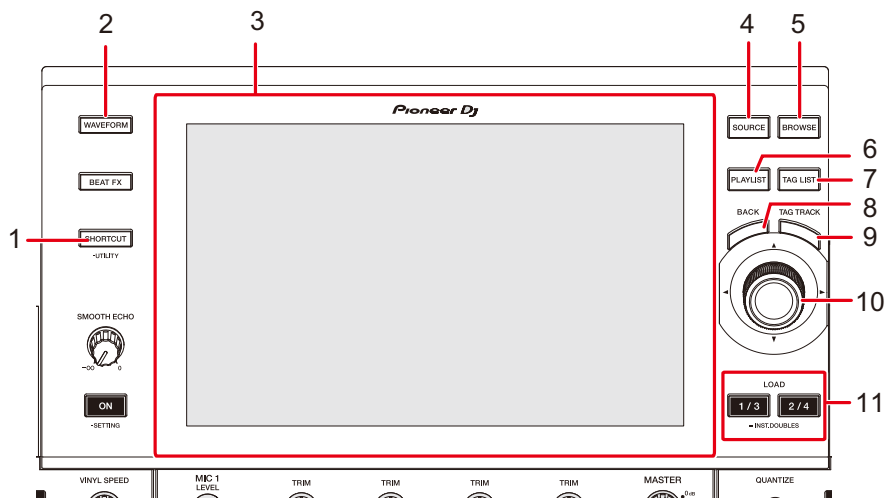

1. **SHORTCUT button** (page 134)
2. **WAVEFORM button**
Displays the [WAVEFORM] screen.
3. **Main display** (page 34)
4. **SOURCE button**
Displays the [SOURCE] screen.
5. **BROWSE button**
Displays the [BROWSE] screen.
6. **PLAYLIST button**
Displays the [PLAYLIST] screen.
7. **TAG LIST button**
Displays the [TAG LIST] screen.
8. **BACK button** (page 41)
9. **TAG TRACK button**
Adds tracks to, or deletes them from, the tag list.
10. **Smart rotary selector** (page 40)
11. **LOAD 1/3, LOAD 2/4 buttons**

Selecting a source

1 Press the [SOURCE] button.

Devices connected to the unit are displayed on the [SOURCE] screen (page 31).

2 Select a device.

Selecting a track

Selecting a track on the browse screen

1 Open the browse screen.

A track list is displayed.

➡ Read more: Browse screen (page 32)

2 Select a track.

➡ Read more: Loading a track to a deck (page 54)

Searching for a track

Using the Search feature

This feature is only available when browsing the rekordbox library.

1 Press the [BROWSE] button.

The [BROWSE] screen appears.

2 Touch (Search).

The Search screen appears.

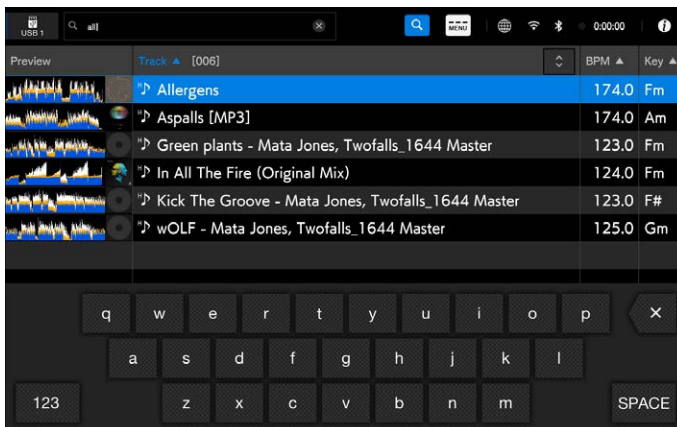

Enter a keyword using the keyboard.

Tracks including the keyword are displayed in the list.

- You can specify multiple keywords by separating them with a space.

Using the Jump feature

The unit supports 2 jump modes.

❖ Alphabet Jump

1 Press and hold the smart rotary selector when the alphabetical order list is displayed.

Alphabet Jump mode turns on, and the first character of the highlighted track or category is displayed on the screen.

- A to Z, 0 to 9, and some symbols are displayed in Alphabet Jump mode.

2 Turn the smart rotary selector to scroll the screen.

The cursor jumps to the track or category whose first character is the same as the displayed character.

- The cursor doesn't jump when there are no tracks or categories whose first character is the same as the displayed character.

❖ Page Jump

1 Press and hold the smart rotary selector when a list other than the alphabetical order list is displayed.

Page Jump mode turns on.

2 Turn the smart rotary selector to scroll the screen.

The cursor jumps to the first track in the list on each page.

Using Track Filter

You can narrow down tracks by BPM, key, or the tag information, etc added by rekordbox. This feature is only available when browsing the rekordbox library.

❖ Narrowing down tracks

1 Display the browse screen.

A track list is displayed.

➡ Read more: Browse screen (page 32)

2 Touch (Track Filter/EDIT).

Tracks are narrowed down by the currently set conditions.

❖ Specifying the conditions on the Track Filter editing screen

1 Display the browse screen.

A track list is displayed.

➡ Read more: Browse screen (page 32)

2 Touch and hold (Track Filter/EDIT).

The Track Filter editing screen appears.

3 Specify the filter conditions.

- You can choose BPM, key, rating, color, or the tag information added by rekordbox as filter conditions.
- Touch to add a check mark to enable the filter conditions.
- Touch **[MASTER DECK]** to read the BPM and key of the track playing on the deck set as the sync master.
- You can set the Track Filter conditions in rekordbox.
- The filter conditions are saved independently for each storage device (USB).

Searching by key of the track playing

The key icons of tracks which are good matches with the key (related key) of the track loaded to the master deck are displayed in green.

- This function isn't available when no deck is set as the sync master.

Monitoring sound before loading a track (Touch Preview)

You can monitor the sound of a track before loading the track.

1 Connect headphones to the unit.

- Read more: Front panel (page 29)

2 Touch the waveform displayed in the track list or tilt the smart rotary selector left or right.

Monitor the sound from the touched point with your headphones.

- You can monitor the sound of a track while touching the waveform or tilting the smart rotary selector left or right even when outputting the sound of a track that's playing on the unit.
- You can't monitor the sound of tracks which can't be loaded to the decks.

- Read more: Browse screen (page 32)

Loading a track to a deck

1 Select a track in the track list.

➡ Read more: Selecting a track (page 49)

2 Press the [LOAD 1/3] or [LOAD 2/4] button.

The track is loaded to the corresponding deck.

- You can't load another track while a track is playing when [Load Lock] is set to [Lock] in the Utility settings (pages 123). Set it to [Unlock], or press the [▶/||] button to pause playback, and then load another track.
- When Auto Cue is turned on, playback is paused at the start of a track. Press the [▶/||] button to start playback.

Loading a track using the track menu

You can display the track menu by pressing the smart rotary selector when a track is selected on the Browse, Playlist, Search, or Tag List screen.

You can then load a track from the track menu.

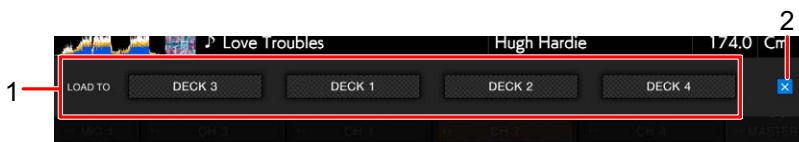

1. **LOAD TO DECK 1 to 4**

Loads a track to the deck and starts playback.

2. **✕ (Cancel)**

Closes the track menu.

Using History

Tracks played for approximately 1 minute are recorded in the History (playback list) (up to 999 tracks).

- A new History is automatically created on a storage device (USB) when it's connected to the unit.
- If you play a track more than once in succession, it may not be recorded in History.
- The information such as name of tracks recorded in History is displayed in green (indicates that the track has been played).
- You can create a playlist from the History using rekordbox. For details, refer to the rekordbox (Mac/Windows) Instruction Manual (page 8).

Viewing History

1 Press the [BROWSE] button.

The [BROWSE] screen appears.

2 Select [HISTORY] in the category.

The History list is displayed.

Deleting History

1 Select a History you want to delete in the History list and touch [MENU].

The deletion menu appears.

2 Select [DELETE] or [ALL DELETE].

- [DELETE]: Deletes the selected History.
- [ALL DELETE]: Deletes all History lists.

- If you create a playlist from the History using rekordbox, the HISTORY is deleted from the storage device (USB).

Using the Tag List

You can tag a track you want to play next or tracks you think will work well in your performance and review them via the Tag List.

- One Tag List is created for each storage device (USB) or each CloudDirectPlay. A track can't be registered to multiple storage devices (USB).
- Up to 100 tracks can be registered to the Tag List on each storage device (USB).
- A track can't be registered to a Tag List more than once.

Tag list screen

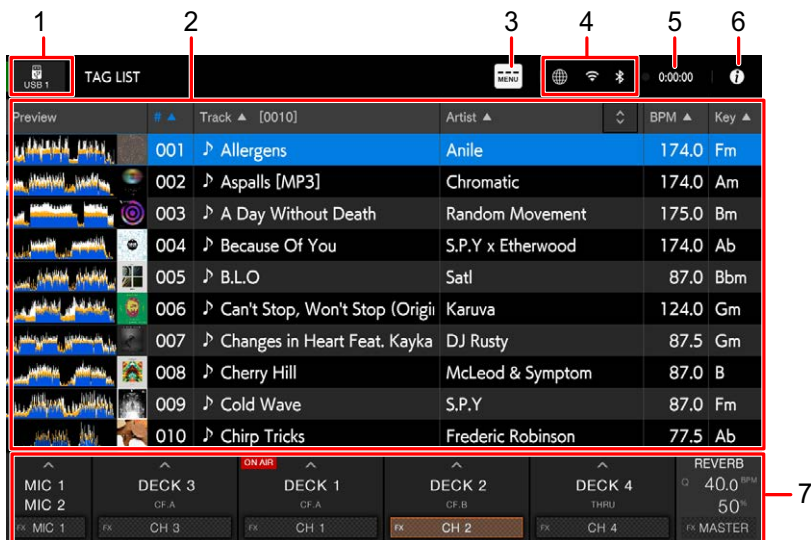

1. Device icon

Displays the icon of a device selected on the [SOURCE] screen (page 31).

2. Tag list



Displays the Preview waveform, artwork, serial number, and track list in the taglist.

- Touch the waveform in the [PREVIEW] column to monitor the sound before loading a track (page 53).
- Touch the title row to sort the list.
- Touch on the title row to display the sub-column selection screen and select a sub-column to be displayed. (To set sub-columns you want to display in the selection list, go to [Preferences] in rekordbox.)

3. **MENU**

Displays [**MENU**] on the mixer information display.

4. **Connection status icons**

-  (Internet connection icon): Displays the status of the internet connection.
-  (Wi-Fi connection icon): Displays the status of the Wi-Fi connection.
-  (Bluetooth connection icon): Displays the status of the Bluetooth connection.

5. **Rec timer**

Displays the recording time when using Master Rec (page 68).

6. **(Information)**

Touch to display or hide the detailed information for the track highlighted in the list.

7. **Mixer information display**

Displays the information for MIC, channels, and effects, etc.

Registering a track to the Tag List

1 Highlight a track.

- You can add tracks included in a folder or playlist to the Tag List instantly by selecting a folder or playlist.

2 Press the [TAG TRACK] button.

A check mark is displayed for the tracks registered to the Tag List.

Deleting a track from the Tag List

❖ Deleting an individual track on the Tag List screen

1 Highlight a track.

2 Press and hold the [TAG TRACK] button.

The track is deleted from the Tag List.

❖ Deleting an individual track on the Browse, Playlist or Search screen

1 Highlight a track.

2 Press the [TAG TRACK] button.

The track is deleted from the Tag List.

❖ Deleting all tracks at once

1 Press the [TAG LIST] button.

The [TAG LIST] screen appears.

2 Touch [MENU].

[MENU] is displayed.

3 Select [REMOVE ALL TRACKS] in [MENU].

All tracks in the Tag List are deleted.

- If you delete a track from the Tag List while playing, the track continues to play until the end. The next track won't play.

Converting the Tag List to a playlist

A playlist converted from the Tag List is displayed in the **[PLAYLIST]** category.

- You can't convert the Tag List to a playlist if the rekordbox library isn't saved on the storage device (USB) or CloudDirectPlay.
- If a mixture of tracks – some managed and some not managed by rekordbox – are registered in the Tag List, only the tracks managed by rekordbox are converted to a playlist.

1 Press the **[TAG LIST]** button.

The **[TAG LIST]** screen appears.

2 Touch **[MENU]**.

[MENU] is displayed.

3 Select **[CREATE PLAYLIST]** in **[MENU]**.

The Tag List is converted to a playlist with the name **[TAG LIST XXX]**.

Displaying the playlist screen

Playlist screen

Press the [PLAYLIST] button to display the [PLAYLIST] screen. You can also display the [PLAYLIST] screen from the browse screen (page 32).

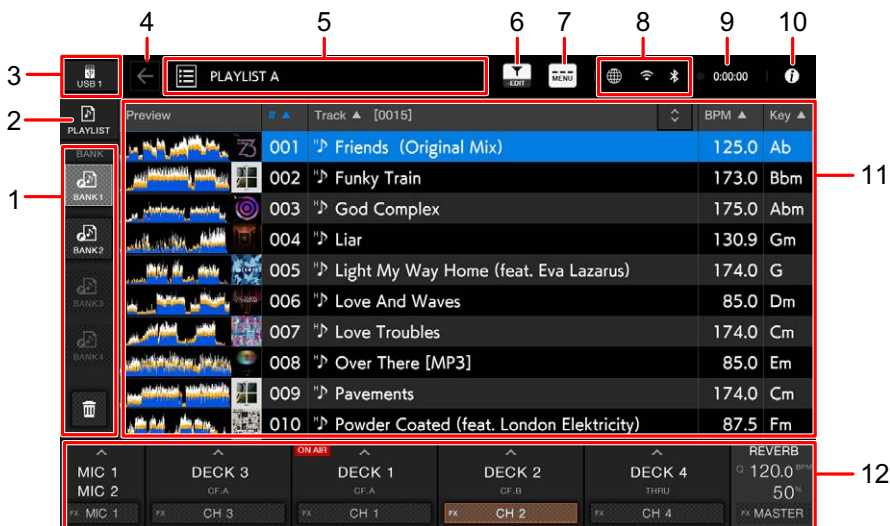

1. Playlist Bank

Displays the playlist when a playlist is registered to a Playlist Bank (page 62). With Playlist Banks, you can find a playlist without browsing the folder hierarchy.

2. Category

Displays the [PLAYLIST] category.

3. Device icon

Displays the icon of a device selected on the [SOURCE] screen (page 31).

4. ⬅️ (Back)

Displays the next level up.

5. Next level up display



6. ⏴ (Track Filter/EDIT)

Narrows down tracks by Track Filter (page 52).

7. MENU

Displays [MENU] on the mixer information display.

8. Connection status icons

-  (Internet connection icon): Displays the status of the internet connection.
-  (Wi-Fi connection icon): Displays the status of the Wi-Fi connection.
-  (Bluetooth connection icon): Displays the status of the Bluetooth connection.

9. Rec timer

Displays the recording time when using Master Rec (page 68).

10. (Information)

Touch to display or hide the detailed information for the track highlighted in the list.

11. Track list

Displays the Preview waveform, artwork, serial number, and the track list in the playlist.

- Touch the waveform in the **[PREVIEW]** column to monitor the sound before loading a track (page 53).
- Touch the title row to sort the list.
- Touch  on the title row to display the sub-column selection screen and select a sub-column to be displayed. (To set sub-columns you want to display in the selection list, go to **[Preferences]** in rekordbox.)

12. Mixer information display

Displays the information for MIC, channels, and effects, etc.

❖ Changing the status of a track in a playlist to **PLAYED** or **UNPLAYED**

- You can also change the status of a track in other lists than a playlist in the same way.

1 Touch **[MENU]** when a track in a playlist is selected.

[MENU] is displayed.

2 Select **[PLAYED]** or **[UNPLAYED]**.

- **[PLAYED]**: Sets unplayed tracks to “played”. Tracks set to “played” are displayed in green and registered to the History.
You can't select **[PLAYED]** when a played track is selected.
- **[UNPLAYED]**: Sets played tracks to “unplayed”. Tracks set to “unplayed” are displayed in white and deleted from the History.
You can't select **[UNPLAYED]** when an unplayed track is selected.

❖ Deleting a playlist

1 Touch [MENU] on the [PLAYLIST] screen.

[MENU] is displayed.

2 Select [DELETE] or [ALL DELETE].

- [DELETE]: Deletes the selected playlist.
- [ALL DELETE]: Deletes all playlists.

Registering a playlist to a Playlist Bank

1 Highlight a playlist on the [PLAYLIST] screen.

2 Select a Playlist Bank whose icon is displayed in gray.

The playlist is registered to the Playlist Bank and the icon turns white.

- Select a Playlist Bank with a white icon to display tracks in the registered playlist.

Deregistering a playlist from a Playlist Bank

1 Select in the Playlist Bank.

Deregistration mode turns on and × is displayed alongside Playlist Bank icons.

2 Select the Playlist Bank to deregister the playlist from.

The playlist is deregistered and deregistration mode turns off.

Playback

Deck section

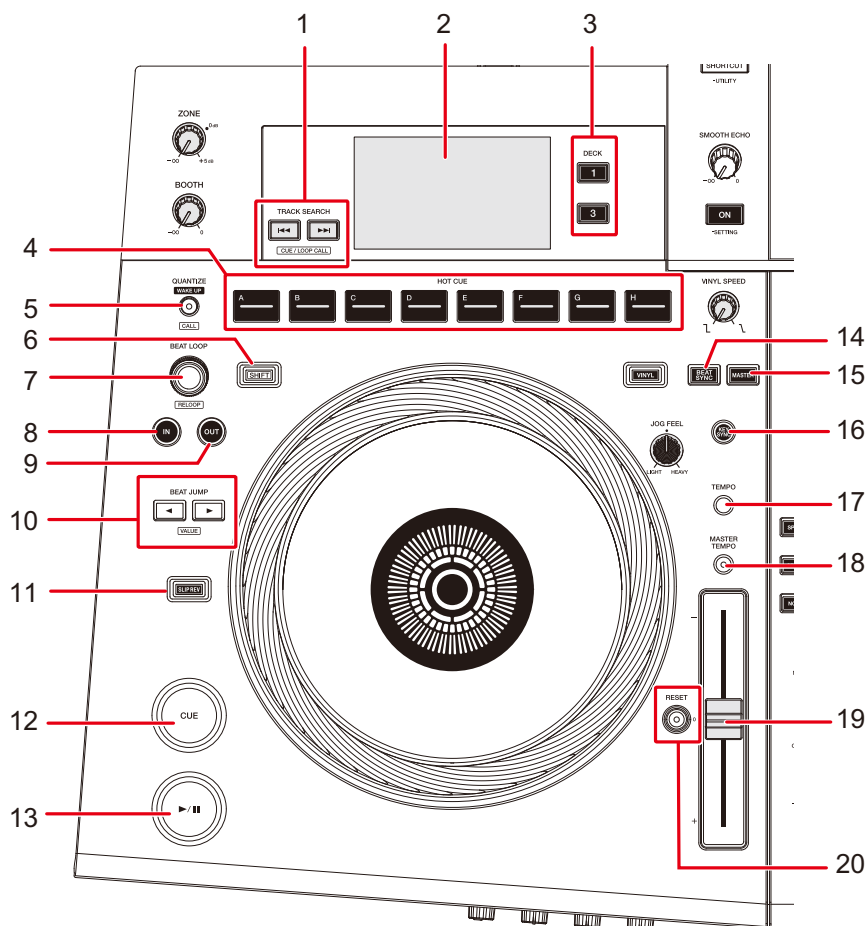

1. TRACK SEARCH ◀◀, ▶▶ buttons

- TRACK SEARCH ▶▶: Jumps to the beginning of the next track.
- TRACK SEARCH ◀◀: Jumps to the beginning of the track that's playing. Press twice to jump to the beginning of the previous track.
- Press while pressing the [SHIFT] button: Calls up saved cue points/loops (pages 73, 78).

2. Deck display (page 37),

3. **Deck buttons**

Selects the deck to use.

4. **HOT CUE (A to H) buttons** (page 80)

5. **QUANTIZE (for deck) button** (page 85)

6. **SHIFT button**

7. **BEAT LOOP knob** (pages 75, 76, 77, 81)

8. **LOOP IN button** (pages 72, 75)

9. **LOOP OUT button** (pages 72, 75)

10. **BEAT JUMP ◀, ▶ buttons** (page 84)

11. **SLIP REV button** (page 65)

12. **CUE button (page 72)**

13. **▶/|| button**

Plays or pauses a track.

14. **BEAT SYNC button** (page 86)

15. **MASTER button** (page 86)

16. **KEY SYNC button** (page 89)

17. **TEMPO button**

Sets the variable range of the TEMPO slider.

18. **MASTER TEMPO button**

Turns Master Tempo on and off.

19. **TEMPO slider** (page 66)

20. **RESET button, Tempo Reset indicator**

Resets to the track's original speed regardless of the TEMPO slider's setting.

The Tempo Reset indicator lights up when Tempo Reset is turned on.

Play/pause

1 Press the [▶/||] button.

- During pause: Starts playing the loaded track.
- During playback: Pauses the track.
- Playback of the next track doesn't automatically start when [Play Mode] is set to [Single] in the Utility settings (page 124).

- Pausing playback in Vinyl mode mutes the sound, and in Normal mode it will output the sound intermittently (page 70).

Playing a track from the touched point on the overall waveform

1 Touch the overall waveform during pause or while pressing the top of the jog wheel in Vinyl mode.

The loaded track plays from the touched point.

- You can quickly move the playback point by sliding your finger to the point you want on the overall waveform.

Reverse playback

❖ Slip Reverse

1 Press and hold the [SLIP REV] button.

The button lights up and the loaded track plays in reverse while normal playback continues in the background.

- When the button is released, playback starts from the exact point the track would have reached by then.

❖ Reverse

1 Press the [SLIP REV] button while pressing the [SHIFT] button.

The button lights up and the loaded track plays in reverse.

- Acceleration and deceleration of playback according to jog wheel rotation are also reversed.
- Maintaining reverse playback from one track to the next isn't possible.

- You may not be able to scratch if you perform Track Search or loop playback during reverse playback.

Adjusting the playback speed (tempo control)

1 Move the TEMPO slider.

- To the [+] side: Increases the playback speed.
 - To the [-] side: Decreases the playback speed.
- The variable range of the TEMPO slider changes in the order of ± 6 (0.02%) \rightarrow ± 10 (0.05%) \rightarrow ± 16 (0.05%) \rightarrow WIDE (0.5%) each time you press the [TEMPO] button*. The adjustable range of [WIDE] is $\pm 100\%$. The track stops when it's set to -100%.
* The value in parentheses indicates the adjustment unit.

Adjusting the playback speed without changing the pitch (Master Tempo)

If you turn Master Tempo on, you can change the playback speed of a track using the TEMPO slider without changing the pitch.

1 Press the [MASTER TEMPO] button to turn Master Tempo on.

The button lights up when Master Tempo is turned on.

- Press the [MASTER TEMPO] button again to turn off Master Tempo.

Monitoring a different part of a track during playback (Touch Cue)

If you touch the overall waveform while a track is playing, you can monitor the sound from the touched point without affecting the output sound.

1 Connect headphones to the unit.

➡ Read more: Front panel (page 29)

2 Touch the overall waveform on the main display (waveform screen).

You can monitor the sound from the touched position with your headphones.

- The waveform of the touched point is zoomed in on and displayed as an enlarged waveform.

Recording

You can record the same audio as the output from the **[MASTER 1]** and **[MASTER 2]** terminals into a WAV file on a storage device (USB).

- The recorded file name will be “REC***.WAV” (*** is a 3-digit number).
- Because this unit doesn’t have a clock, the recording time and date aren’t registered on the storage device (USB).

1 Insert a USB device to a USB port on the unit.

➡ Read more: USB section (page 46)

2 Press the **[SHORTCUT]** button.

The **[SHORTCUT]** screen appears.

3 Select the USB device and touch **[Rec]**.

Recording starts.

- Recording isn’t available when **[Bluetooth]** is selected with the input selector.
- You can record for approximately 90 minutes on a storage device (USB) with 1GB of free space.
- Touch **[Rec]** again to end recording. Recording stops and the button light turns off.

Splitting a track during recording

1 Press the **[SHORTCUT]** button.

The **[SHORTCUT]** screen appears.

2 Touch **[Track Mark]** during recording.

The file is split at the point where **[Track Mark]** is touched, and the recording continues as a new file from the split point.

Using the jog wheel

Jog wheel section

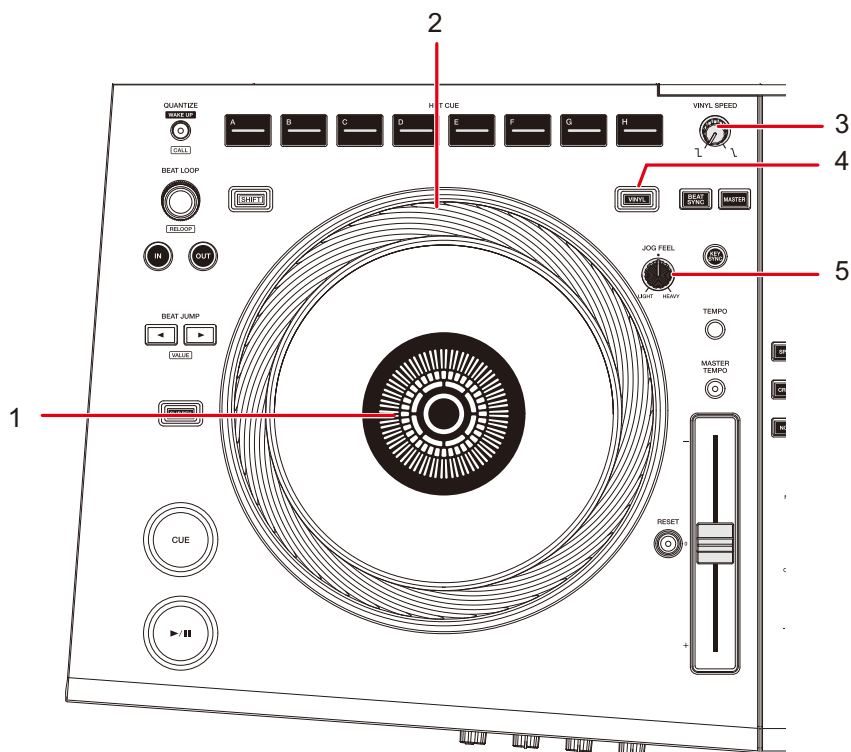

1. **Jog display** (page 39)
2. **Jog wheel**
 - A sensor is built into the top of the jog wheel. Do not place anything on it or apply strong force.
3. **VINYL SPEED knob**

Adjusts the speed at which playback slows down and stops after the top of the jog wheel is pressed and the speed at which normal playback resumes after the top of the jog wheel is released.
4. **VINYL button**

Sets the jog wheel mode.
5. **JOG FEEL knob**

Adjusts the 'weight' of the jog wheel.

Setting the jog wheel mode

1 Press the [VINYL] button.

Each press switches between the following modes. The button lights up in Vinyl mode.

- **Vinyl mode:** Stops playback with a press on the top of the jog wheel and scratches a track by turning the jog wheel while pressing the top.
- **Normal mode:** Doesn't stop playback or scratch a track with the operations of the jog wheel.

Jog wheel operations

You can use the following features in combination with the jog wheel.

Function	Description
Pitch Bend	<p>Turn the outer section of the jog wheel clockwise during playback to increase the playback speed, and counterclockwise to decrease it. Stop turning it to resume the normal playback speed.</p> <ul style="list-style-type: none"> • In Normal mode, you can perform the same operations by turning the jog wheel while pressing the top.
Scratch	<p>Turn the jog wheel while pressing the top during playback in Vinyl mode to scratch a track.</p> <p>Release the jog wheel to resume normal playback.</p>
Frame Search	<p>Turn the jog wheel during pause to move the pause position.</p> <ul style="list-style-type: none"> • One full rotation moves the position by 1.8 seconds.
Fast-forward/fast-reverse	<p>Turn the jog wheel while pressing the [SHIFT] button to fast-forward or fast-reverse with extra speed.</p>
Super Fast Track Search	<p>Turn the jog wheel while pressing the [TRACK SEARCH ◀◀] or [TRACK SEARCH ▶▶] button to cycle through tracks with extra speed according to the rotation direction.</p>

Adjusting the “weight” of the jog wheel

1 Turn the [JOG FEEL] knob.

- Turn clockwise: Increases the weight.
- Turn counterclockwise: Decreases the weight.

Adjusting the playback starting and stopping speeds (for Vinyl mode)

You can adjust the following speeds.

- The speed at which playback slows down and stops after the top of the jog wheel is pressed or the [▶/||] button is pressed
- The speed at which normal playback resumes after the top of the jog wheel is released or the [▶/||] button is pressed

1 Press and hold the [SHORTCUT] button.

The [UTILITY] screen appears.

2 Select an adjustment setting in [Vinyl Speed Adjust].

- [Touch&Release]: Adjusts the speed at which playback slows down and stops, and normal playback resumes.
- [Touch]: Adjusts the speed at which playback slows down and stops.
- [Release]: Adjusts the speed at which normal playback resumes.

3 Turn the [VINYL SPEED] knob.

- Turn counterclockwise: Increases the speed.
- Turn clockwise: Decreases the speed.

Cueing

You can quickly call up a cue point you have set previously.

Setting a cue point

❖ During pause

1 Press the [CUE] button.

A cue point is set.

- Turn the jog wheel during pause to fine-adjust (0.5 frame unit) the pause position.

❖ During playback

1 Press the [LOOP IN] button.

A cue point is set.

- If you set a new cue point, the previously set cue point is cleared.
- When [On] is set for [Overwrite Current Cue with Hot Cue] in the Utility settings, if you set a Hot Cue or start playback from a Hot Cue, the point is set as a cue point (page 123).

Jumping to a cue point

1 Press the [CUE] button during playback.

The track jumps to the cue point and playback is paused.

- If a comment has been set to the cue point, the comment is displayed in the track name display.

Checking a cue point (Cue Point Sampler)

1 Jump to a cue point.

➡ Read more: Jumping to a cue point (page 72)

2 Press and hold the [CUE] button.

Playback continues while pressing the [CUE] button.

- Press the [▶/||] button to continue playback even if you release the [CUE] button.

Saving a cue point

1 Set a cue point.

➡ Read more: Setting a cue point (page 72)

2 Press the [CUE] button while pressing the [SHIFT] button.

- If you do this during cue standby and the saved cue point is same as the cue point in standby, the saved cue point is deleted.

Calling up a saved cue point

1 Load a track you have previously saved a cue point for.

2 Press the [TRACK SEARCH ◀◀] or [TRACK SEARCH ▶▶] button while pressing the [SHIFT] button.

- If a comment has been set to the called up point in rekordbox, the comment is displayed in the track name display.

Deleting a saved cue point

1 Call up a saved cue point.

➡ Read more: Calling up a saved cue point (page 73)

2 Press the [CUE] button while pressing the [SHIFT] button.

Setting Auto Cue

When loading a track or performing Track Search, a cue point can be automatically set to the position immediately before the first sound in the track (skipping any silence at the beginning).

1 Press the [SHORTCUT] button.

The [SHORTCUT] screen appears.

2 Touch [ON] in [Auto Cue].

[A.CUE] is displayed on the deck display when Auto Cue is turned on.

- The Auto Cue setting is retained even if you turn the unit off.
- You can set the sound pressure level that you want to be recognized as silence in [Auto Cue Level] in the Utility settings (page 123).

Looping

You can choose a section of a track to play repeatedly.

Setting a loop

Manual setting

- 1 While the track is playing, press the [LOOP IN] button at the point where you want to start the loop (loop-in point).**
- 2 Press the [LOOP OUT] button at the point where you want the loop to end (loop-out point).**

The chosen section plays in a loop.

Automatic setting

❖ Using 4 Beat Loop

- 1 Press and hold the [LOOP IN] button during playback.**

The track plays a 4-Beat Loop according to the BPM from the point where you pressed the button.

- If BPM can't be detected, it's set to 120.

❖ Using Beat Loop

- 1 Turn the [BEAT LOOP] knob to select the number of beats for the length of a loop.**

2 Press the [BEAT LOOP] knob.

Loop playback starts according to the BPM of the track and the specified number of beats.

- If the BPM can't be detected, it's set to 120.

Fine-adjusting loop points

1 Press the [LOOP IN] or [LOOP OUT] button during loop playback.

The unit switches to loop adjusting mode.

- [LOOP IN]: Adjusts the loop-in point.
- [LOOP OUT]: Adjusts the loop-out point.

2 Turn the jog wheel to fine-adjust the loop point.

- Press the [LOOP IN] or [LOOP OUT] button again, or leave the unit without operating the controls for more than 10 seconds to cancel loop adjusting mode.

Adjusting the length of a loop

Halving the length of a loop

1 Turn the [BEAT LOOP] knob counterclockwise during loop playback.

The loop length is halved.

Doubling a loop in length

- 1 Turn the **[BEAT LOOP]** knob clockwise during loop playback.

The loop length is doubled.

Returning to a loop-in point to start loop playback (Retrigger)

- 1 Press the **[LOOP IN]** button while pressing the **[SHIFT]** button during loop playback.

The playback point returns to the loop-in point and starts loop playback from there.

Using Active Loop

Set a saved loop as an Active Loop using rekordbox beforehand.

- 1 Load a track that has an Active Loop set.

After the playback point passes the set point, loop playback automatically starts.

Canceling loop playback

- 1 Press the **[BEAT LOOP]** knob during loop playback.

Loop playback is canceled.

- Press the **[BEAT LOOP]** knob while pressing the **[SHIFT]** button to start loop playback from the loop-in point.

Emergency Loop

The unit automatically plays a Beat Loop if it can't start playing the next track when the end of the current track is reached. This prevents situations where your performance is interrupted by silence.

- You can't DJ during Emergency Loop playback.
- Load a track to cancel the Emergency Loop.
- When the file has been cached, Emergency Loop isn't applied and playback continues with the restriction.

Saving a loop

1 Set loop points.

➔ Read more: Setting a loop (page 75)

2 Press the [CUE] button while pressing the [SHIFT] button.

Calling up a saved loop

1 Load a track you have previously saved a loop for.

2 Press the [TRACK SEARCH ◀◀] or [TRACK SEARCH ▶▶] button while pressing the [SHIFT] button.

- If a comment is set to the called up point in rekordbox, the comment is displayed in the track name display.

Deleting a saved loop

1 Call up a saved loop.

➡ Read more: Calling up a saved loop (page 78)

2 Press the [CUE] button while pressing the [SHIFT] button.

- If you delete a loop set as an Active Loop, the Active Loop is also deleted (page 77).

Hot Cues

You can quickly call up a Hot Cue point by pressing the **[HOT CUE] (A to H)** buttons and start playback from that point in the track.

Setting a Hot Cue

1 Press one of the **[HOT CUE] (A to H)** buttons at the point where you want to set a Hot Cue.

A Hot Cue is set to the button.

- If you do this during loop playback, a loop is set instead.
 - When **[On]** is set for **[Overwrite Current Cue with Hot Cue]** in the Utility settings, the point is set as a cue point (page 123).
- You can set up to 8 Hot Cues per track.
 - The **[HOT CUE] (A to H)** buttons light up as follows according to the set function. You can change the colors using rekordbox.

Set function	[Hot Cue Color] setting in the Utility settings	
	[Off]	[On]
Cue point	Green	Fixed button color
Loop	Orange	Orange
No setting	No light	No light

- You can't set a Hot Cue to any **[HOT CUE] (A to H)** buttons that have a one set already. To set a new Hot Cue, delete a one from a button first (page 81).

Starting playback from a Hot Cue point

1 Press one of the [HOT CUE] (A to H) buttons that have a Hot Cue set.

Playback starts from the Hot Cue point.

- When [On] is set for [Overwrite Current Cue with Hot Cue] in the Utility settings, the point is set as a cue point (page 123).
- Press the [BEAT LOOP] knob to cancel playback of the loop started with the [HOT CUE] (A to H) button.

Deleting a Hot Cue

1 Press one of the [HOT CUE] (A to H) buttons while pressing the [SHIFT] button.

The Hot Cue set to the button is deleted.

Calling up Hot Cues

Automatic call-up

You can automatically call up Hot Cues saved on a storage device (USB) when a track is loaded.

1 Press and hold or press the [SHORTCUT] button.

The [UTILITY] or [SHORTCUT] screen appears.

2 Set [Hot Cue Auto Load] to [On] or [rekordbox Setting].

- [On]: Automatically calls up Hot Cues from all tracks when loading them.

- **[rekordbox Setting]:** Automatically calls up Hot Cues from tracks with the  icon (indicates that the tracks have **[Hot Cue Auto Load]** set using rekordbox) when loading them.
- **[Off]:** Hot Cues aren't automatically called up when loading a track.

Manual call-up

You can manually call up a Hot Cue saved on a storage device (USB).

1 Press the **[QUANTIZE]** button while pressing the **[SHIFT]** button.

The **[HOT CUE]** (A to H) buttons blink if they have a Hot Cue set.

2 Press one of the blinking **[HOT CUE]** (A to H) buttons.

The set Hot Cue is called up.

- The Hot Cue call-up mode turns off in the following conditions:
 - All Hot Cues are called up.
 - The **[QUANTIZE]** button is pressed in Hot Cue call up mode.
 - The loaded track is replaced by another one.

Using a Hot Cue Bank

You can set Hot Cues to the **[HOT CUE]** (A to H) buttons on the unit using a Hot Cue Bank set with rekordbox.

- Hot Cue Banks can't be edited via the unit. You will need to use rekordbox for editing. For details, see the rekordbox Instruction Manual, available at the URL below.

rekordbox.com/manual

1 Press the **[BROWSE]** button.

The **[BROWSE]** screen appears.

2 Select **[HOT CUE BANK]** in the category.

The Hot Cue Bank list is displayed.

3 Select a Hot Cue Bank.

Hot Cues registered in the selected Hot Cue Bank are displayed.

4 Touch a track in the Hot Cue Bank, or press the smart rotary selector.

- If you specify a deck in LOAD MENU, Hot Cues registered in the Hot Cue Bank are set to the specified deck.

Beat Jump/Loop Move

You can instantly move the playback point without changing the rhythm of a track that's playing.

Using Beat Jump/Loop Move

1 Press the [BEAT JUMP ◀] or [BEAT JUMP ▶] button.

The playback point jumps by the number of beats from the point where the button is pressed.

- If you do this during loop playback, a loop is moved by the number of beats.
- To change the number of beats, press the [BEAT JUMP ◀] or [BEAT JUMP ▶] button while pressing the [SHIFT] button or turn the [BEAT LOOP] knob.

Quantize (for deck)

Cue points, loop-in points, loop-out points, and Hot Cue points are automatically set to the closest beat position even if your timing is off the beat when you set them.

You can use Hot Cues, loop, reverse playback, and Slip Reverse without breaking the rhythm of the track you are playing.

- You can't use the Quantize feature with tracks that haven't been analyzed by rekordbox. For details on track analysis, see the rekordbox Instruction Manual (page 8).
- You can set **[Quantize Beat Value (Deck)]** in the Utility settings or **[Quantize Beat Value]** on the **[SHORTCUT]** screen (pages 123, 134).

Using Quantize

1 Press the **[QUANTIZE]** button.

Quantize turns on, then **[Q]** and the number of beats are displayed on the deck display.

- Press the **[QUANTIZE]** button again to turn Quantize off.

Beat Sync

If you turn Beat Sync on, tempo (BPM) and beat position of tracks on the unit automatically synchronize.

- Beat Sync can't be used with tracks that haven't been analyzed by rekordbox.
- You can set rekordbox for Mac/Windows the sync master. For details, see the rekordbox Instruction Manual (page 8).

Using Beat Sync

1 Play a track analyzed by rekordbox on the deck you want to set as the sync master.

- You can set either deck as the sync master by pressing the **[MASTER]** button on the deck.

2 Play a track analyzed by rekordbox on the deck you want to sync with the sync master.

3 Press the **[BEAT SYNC] button on the deck you want to sync with the sync master.**

Beat Sync turns on.

- Press the **[BEAT SYNC]** button again to turn Beat Sync off.
If the position of the TEMPO slider doesn't match the playback tempo (BPM), the Beat Sync tempo is maintained. To restore normal use of the TEMPO slider, load the track again or move the slider until the BPM matches the playback tempo. After this, you'll be able to use the TEMPO slider to adjust the tempo.

Using Instant Doubles

You can duplicate a track loaded on DECK 1/3 or DECK 2/4 so it plays on the other deck from exactly the same point.

1 Press the [LOAD] button ([LOAD 1/3] or [LOAD 2/4]) twice on the deck where you want the duplicate track to start playing.

- You can also start Instant Doubles by pressing and holding the [BEAT SYNC] button on the deck where you want the duplicate track to start playing.

Beatgrid

You can adjust the beatgrid.

- You can't adjust the beatgrid for tracks that haven't been analyzed by rekordbox.

Adjusting the beatgrid

1 Press and hold the smart rotary selector on the waveform screen.

Grid Adjust mode turns on.

2 Turn the smart rotary selector to adjust the beatgrid.

- You can adjust the beatgrid on the active deck.
- You can also adjust the beatgrid using the following buttons on the mixer information display.
 - **[SNAP GRID(CUE)]**: Moves the first beat position to a cue point.
 - **[SHIFT GRID]**: Applies the settings (Pitch Bend, etc.) adjusted during synchronization.
 - **[<1/2], [1/2>]**: Moves the beatgrid by 1/2 beat.
- Touch **[RESET]** to reset to the original beatgrid.
- To return to Zoom mode, press and hold the smart rotary selector on the waveform screen again.
- Press the deck button to switch between decks.

Key Sync

You can adjust the key of a track playing on the unit to match with the key of a track loaded on the sync master.

- You can't adjust the key for tracks that haven't been analyzed by rekordbox.

Using Key Sync

1 Press the [KEY SYNC] button when a track is loaded.

The key is adjusted to the key with the least change among the following.

- Same key
 - Dominant key
 - Subdominant key
 - Relative key
 - Relative key of dominant key
 - Relative key of subdominant key
- Press the [KEY SYNC] or [MASTER TEMPO] button to reset to the original key.

Key Shift

You can shift the key of a track.

Using Key Shift

- 1 Touch  of the key display on the waveform screen.

The Key Shift screen appears.

- 2 Touch [-] or [+] to adjust the key.

Each touch shifts the key up or down by a semitone.

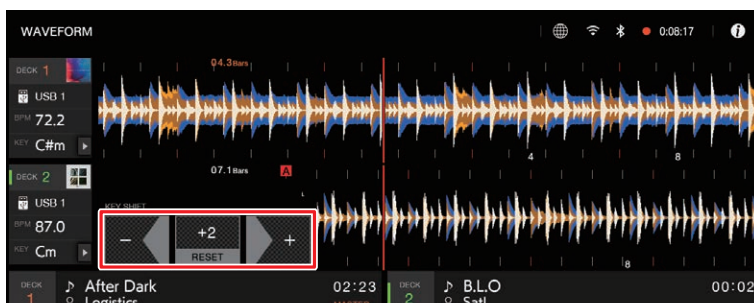

- Touch [RESET] to revert to the original key.

Audio output

Follow the procedures below to output and adjust sound.

- Outputting sound (page 93)
- Adjusting the sound (page 94)
- Setting the faders (page 95)

Channel section/master section

Top panel:

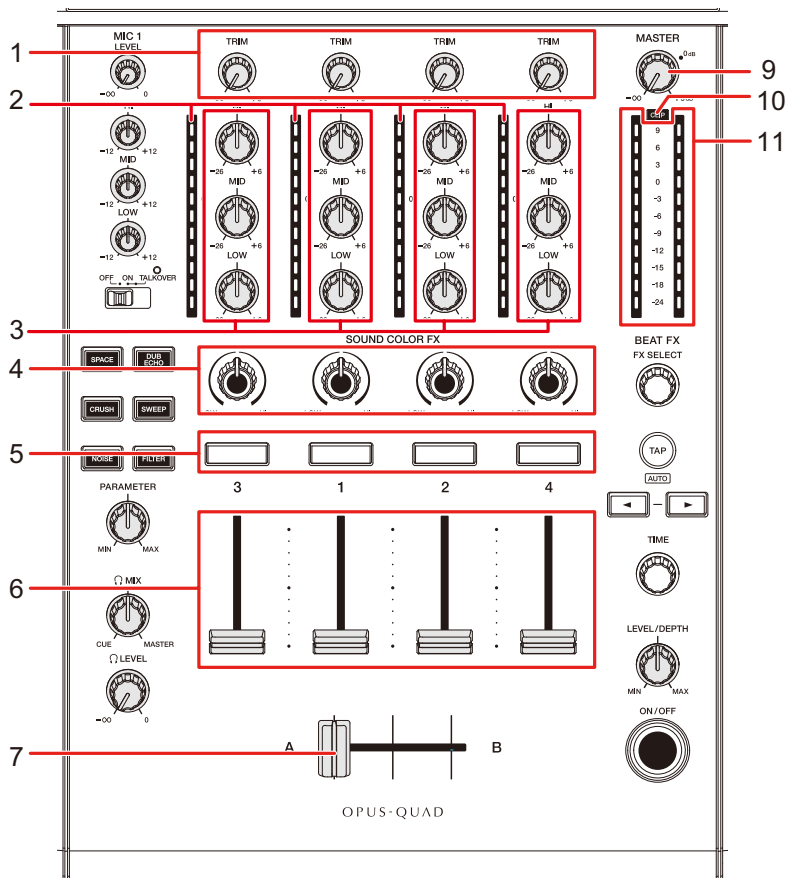

Touch screen:

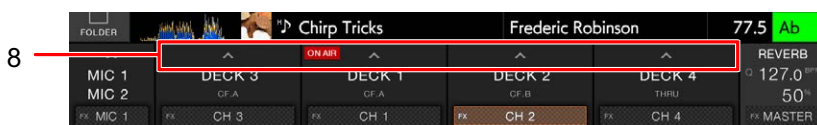

❖ Channel section

1. TRIM knob

Adjusts the volume for the channel input sound.

2. Channel level indicator

Displays the volume level before the sound passes through the channel fader.

3. EQ/ISO (HI, MID, LOW) knobs

Adjusts the volume of each frequency band.

Each knob adjusts in the following range.

- **[HI]**: -∞ dB to +6 dB (ISO)/-26 dB to +6 dB (EQ)
- **[MID]**: -∞ dB to +6 dB (ISO)/-26 dB to +6 dB (EQ)
- **[LOW]**: -∞ dB to +6 dB (ISO)/-26 dB to +6 dB (EQ)

4. COLOR knob (page 104)

5. CUE button (page 96)

6. Channel fader

Adjusts the volume for the channel output sound according to the channel fader curve set with **[Channel Fader Curve]** in the Utility settings or on the **[SHORTCUT]** screen (pages 125, 135). Moving it up increases the volume, and down decreases the volume.

7. Crossfader

Adjusts the volume balance between the channel output sounds specified with **[CROSSFADER ASSIGN (A, THRU, B)]** according to the crossfader curve specified with **[Crossfader Curve]** in the Utility settings or on the **[SHORTCUT]** screen (pages 125, 135).

8.

- Input selector: Selects the input source for **[CH 3]** or **[CH 4]** from devices connected to the unit.
 - **[DECK 3], [DECK 4]**: Selects a deck on the unit.
 - **[LINE]**: Selects a multi player, etc. connected to the **[LINE/PHONO]** terminals.
 - **[PHONO]**: Selects a turntable connected to the **[LINE/PHONO]** terminals.
 - **[Bluetooth]**: Selects a PC/Mac or mobile device connected via Bluetooth.
- **[CROSSFADER ASSIGN (A, THRU, B)]** selector: Assigns the channel output sound to the crossfader in **[CROSSFADER ASSIGN]**.
 - **[A]**: Assigns to the **[A]** (left) side.
 - **[THRU]**: Bypasses the crossfader (it doesn't pass through the crossfader).
 - **[B]**: Assigns to the **[B]** (right) side.

❖ Master section

9. MASTER level knob

Adjusts the volume for the master sound.

10. CLIP indicator

Blinks when excessive volume is output from the [MASTER 1] or [MASTER 2] terminals.

11. Master level indicator

Displays the volume level of the master sound output to the [MASTER 1] and [MASTER 2] terminals.

Outputting sound

Adjusting the channel input volume

1 Touch  on the mixer information display.

2 Select the input source for [CH 3] or [CH 4].

- Skip this step when outputting the sound of [CH 1] or [CH 2].

3 Turn the [TRIM] knob to adjust the volume for the input sound.

The channel level indicator lights up when sound is input to the channel.

Adjusting the channel output volume

- 1 Move the channel fader to adjust the volume for the output sound.
- 2 Touch  on the mixer information display.
- 3 Select the output destination of the channel in the [CROSSFADER ASSIGN (A, THRU, B)] selector setting.
- 4 Move the crossfader to adjust the volume balance of the two channels.
 - You don't need to adjust the crossfader when the [CROSSFADER ASSIGN (A, THRU, B)] is set to [THRU].

Adjusting the master sound volume

- 1 Turn the MASTER level knob to adjust the volume for the master sound.

The master level indicator lights up when the master sound is output.

Adjusting the sound

- 1 Turn the EQ/ISO (HI, MID, LOW) knobs to adjust the volume of each band.
 - Set the function (equalizer or isolator) to adjust with the EQ/ISO (HI, MID, LOW) knobs in [EQ/ISO] in the Utility settings or on the [SHORTCUT] screen (pages 125, 135).

Setting the faders

Set the channel fader and crossfader.

Setting the channel fader

1 Press and hold or press the [SHORTCUT] button.

The [UTILITY] or [SHORTCUT] screen appears.

2 Set the channel fader curve in [Channel Fader Curve].





➡ Read more: Channel Fader Curve (pages 125, 135).

Setting the crossfader

1 Press and hold or press the [SHORTCUT] button.

The [UTILITY] or [SHORTCUT] screen appears.

2 Select the crossfader curve in [Crossfader Curve].

- : Steeply raises the volume of the sound assigned to the other side as the crossfader is moved from one side ([A] or [B]) to the other (e.g. moving the crossfader away from the [A] side steeply increases the volume of the [B] side).
- : Applies the intermediate setting between  and .
- : Gradually raises the volume of the sound assigned to the other side as the crossfader is moved from one side ([A] or [B]) to the other, and decreases the volume of the sound on the side it's moving away from (e.g. moving the crossfader away from the [A] side gradually increases the volume of the [B] side while gradually decreasing the volume of the [A] side).

➡ Read more: Crossfader Curve (pages 125, 135)

Monitoring sound

Headphones section

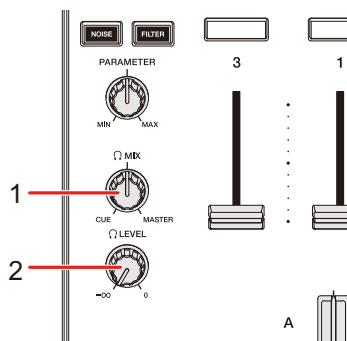

1. MIX knob

Adjusts the volume balance between the master sound and the sound of the channel selected with the **[CUE]** button, **ZONE**, **Touch Preview**, or **Touch Cue**.

- Set the knob to **[CUE]** to monitor only the sound of the selected channel, **ZONE**, **Touch Preview**, or **Touch Cue**, or set it to **[MASTER]** to monitor only the master sound.

2. LEVEL knob

Adjusts the volume for sound output from the **PHONES** terminals.

Monitoring with headphones

1 Connect headphones to one of the **PHONES** terminals.

➔ Read more: **Front panel** (page 29)

2 Press the **[CUE]** button on a channel to monitor the channel's sound.

- Skip this step when monitoring the sound of **Touch Preview** or **Touch Cue**.

- To monitor the sound of the ZONE, keep touching **[Preview]** on the **[SHORTCUT]** screen.
- You can set the sound output (Mono Split or Stereo) in **[Headphones Mono Split/ Stereo]** in the Utility settings or on the **[SHORTCUT]** screen (pages 125, 135).

3 Turn the [MIX] knob to adjust the volume balance between the channel sound and the master sound.

4 Turn the [LEVEL] knob to adjust the volume.

Booth section

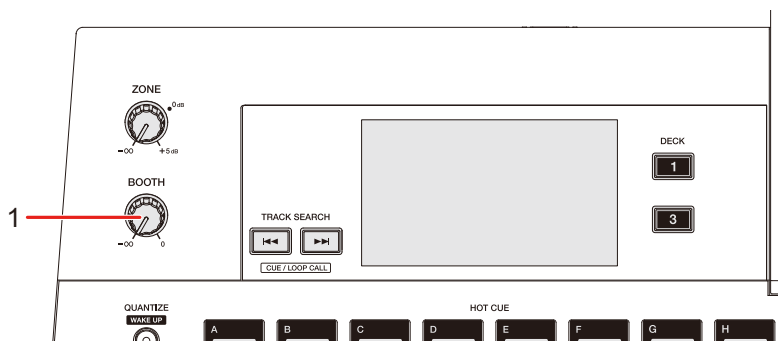

1. BOOTH level knob

Adjusts the volume for the sound output to a booth monitor.

Using a booth monitor

1 Connect a booth monitor to the [BOOTH] terminals.

📖 Read more: Rear panel (page 29)

2 Turn the BOOTH level knob to adjust the volume for the output sound.

Microphone

MIC section

Top panel (for MIC 1):

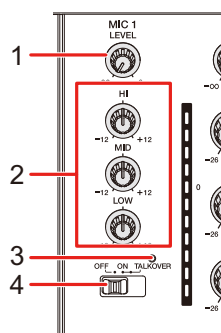

Front panel (for MIC 2):

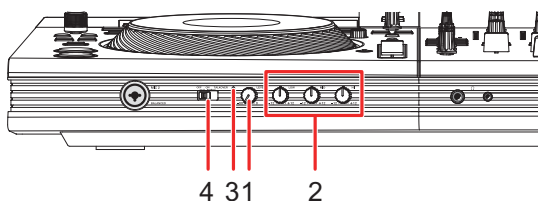

1. LEVEL knob

Adjusts the volume of sound input from the [MIC 1] or [MIC 2] terminal.

2. MIC EQ (HI, MID, LOW) knobs

Adjusts the volume of sound input from the [MIC 1] or [MIC 2] terminal.

Each knob adjusts in the following range.

- [HI]: -12 dB to +12 dB (10 kHz)
- [MID]: -12 dB to +12 dB (2.5 kHz)
- [LOW]: -12 dB to +12 dB (100 kHz)

3. MIC indicator

Indicates the microphone sound output as follows.

- Off: The microphone is off.
- Lights up: The microphone is on.
- Blinks: The microphone talkover is on.

4. **OFF, ON, TALKOVER selector switch**

Sets the microphone sound output.

- **[OFF]**: Turns the microphone off.
 - **[ON]**: Turns the microphone on.
 - **[TALKOVER]**: Turns microphone talkover on. When sound is input to the microphone, the volume other than the microphone channel is attenuated by -24 dB.
- You can change the talkover mode setting and attenuation level in **[Talkover Mode]** in the Utility settings (page 126).

Using a microphone

1 **Connect a microphone to the [MIC 1] or [MIC 2] terminal.**

📖 Read more: Front panel (page 29), Rear panel (page 29)

2 **Slide the [OFF, ON, TALKOVER] selector switch to set the microphone sound output.**

3 **Turn the [LEVEL] knob to adjust the microphone volume level.**

- Note that turning the knob too far clockwise outputs the sound at a high volume.

4 **Turn the MIC EQ (HI, MID, LOW) knobs to adjust the volume of each band.**

5 **Speak into the microphone.**

Reducing the “howling” noise of a microphone (Feedback Reducer)

When microphone “howling” noise occurs (feedback), the unit detects the relevant frequency and cuts only that frequency band to reduce the “howling” while minimizing the effect on sound quality.

1 Touch of MIC on the mixer information display.

The [MIC] menu is displayed.

2 Select a mode.

[FEEDBACK REDUCER] is turned [ON].

- [HEAVY]: The filter cuts a wide frequency band. Choose this setting when your priority is reducing “howling” noise, e.g. when you’re using a microphone for a speech or to introduce speakers.
 - [LIGHT]: The filter cuts a narrow frequency band. Choose this setting when you want to prioritize sound quality, e.g. when you’re singing or rapping.
- Touch [OFF] to turn off [FEEDBACK REDUCER].

ZONE

ZONE section

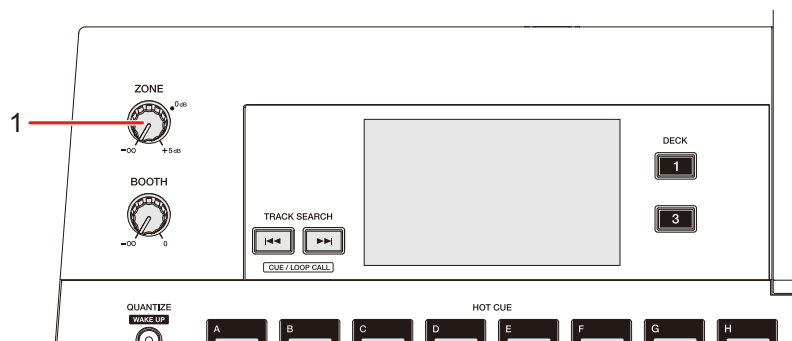

1. ZONE level knob

Adjusts the volume for the sound of ZONE.

- You can output sound from the [ZONE] terminals separately from the sound output from the master channel.

Using ZONE

1 Press the [SHORTCUT] button.

The [SHORTCUT] screen appears.

2 Select a channel to output its sound from the [ZONE] terminals in [Zone Assign].

- The output sound differs depending on the selected channel.
 - [CH 3], [CH 4]: Outputs the sound regardless of the fader position.
 - [MASTER]: Outputs the sound regardless of the [MASTER] knob position.

3 Touch [ON] for [Zone].

The ZONE output is turned on.

4 Turn the ZONE level knob.

The sound is output from the [ZONE] terminals.

- Touch [ON] for [Zone] on the [SHORTCUT] screen again to turn off the ZONE output.

Sound Color FX

Sound Color FX section

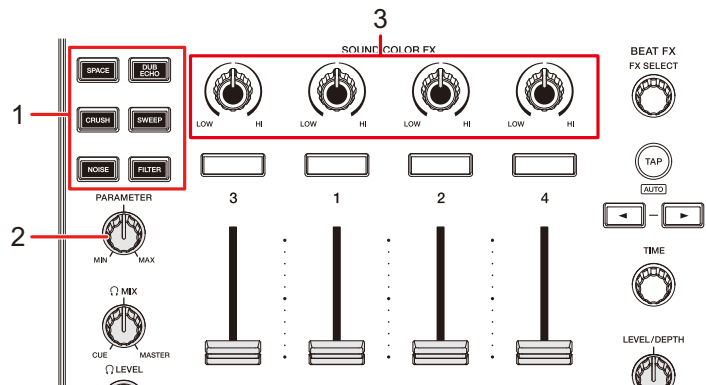

1. **SOUND COLOR FX buttons**
Select a SOUND COLOR FX.
2. **PARAMETER knob**
Adjusts a filter or an effect.
3. **COLOR knobs**
Adjusts an effect.

Using Sound Color FX

➡ Read more: Sound Color FX types and settings (page 105)

1 Press the **SOUND COLOR FX** button.

The selected button blinks.

- The effect is applied to CH 1 to CH 4.

2 Turn the **COLOR** knob to adjust the effect.

The effect on the channel you turned the knob for is adjusted.

3 Turn the **[PARAMETER]** knob to adjust the quantitative parameter for the effect.

- Press the button of the effect you're using again to turn the effect off.

Sound Color FX types and settings

You can adjust the following settings with the knobs.

Effect/operation	Description
SPACE	Adds reverberation to the original sound.
<ul style="list-style-type: none"> • COLOR: 	<p>Turn counterclockwise to add reverberation to the middle frequency range and high frequency range.</p> <p>Turn clockwise to add reverberation to the middle frequency range and low frequency range.</p>
<ul style="list-style-type: none"> • PARAMETER: 	Feedback
DUB ECHO	Adds reverberating echo by outputting the sounds slightly delayed from the original sound several times and attenuating them.
<ul style="list-style-type: none"> • COLOR: 	<p>Turn counterclockwise to add reverberating echo to the middle frequency range.</p> <p>Turn clockwise to add reverberating echo to the high frequency range.</p>
<ul style="list-style-type: none"> • PARAMETER: 	Feedback
SWEEP	Adds a gate effect (makes the sound tighter and reduces the volume) or a bandpass filter effect.
<ul style="list-style-type: none"> • COLOR: 	<p>Turn counterclockwise to add a gate effect.</p> <p>Turn clockwise to gradually narrow the bandwidth of the bandpass filter.</p>
<ul style="list-style-type: none"> • PARAMETER: 	Effect level

Effect/operation	Description
NOISE	Outputs filtered white noise mixed with the sound of the channel.
<ul style="list-style-type: none"> • COLOR: 	<p>Turn counterclockwise to lower the cut-off frequency for the filter which passes white noise through.</p> <p>Turn clockwise to raise the cut-off frequency for the filter which passes white noise through.</p>
<ul style="list-style-type: none"> • PARAMETER: 	Volume of the noise
<ul style="list-style-type: none"> • EQ/ISO (HI, MID, LOW): 	Volume of the noise
CRUSH	Outputs a 'crushed' version of the original sound.
<ul style="list-style-type: none"> • COLOR: 	<p>Turn counterclockwise to increase sound distortion.</p> <p>Turn clockwise to pass the crush sound through the high-pass filter.</p>
<ul style="list-style-type: none"> • PARAMETER: 	Effect level
FILTER	Outputs filtered sound.
<ul style="list-style-type: none"> • COLOR: 	<p>Turn counterclockwise to lower the cut-off frequency of the low-pass filter.</p> <p>Turn clockwise to raise the cut-off frequency of the high-pass filter.</p>
<ul style="list-style-type: none"> • PARAMETER: 	Resonance

Beat FX

Beat FX section

Top panel:

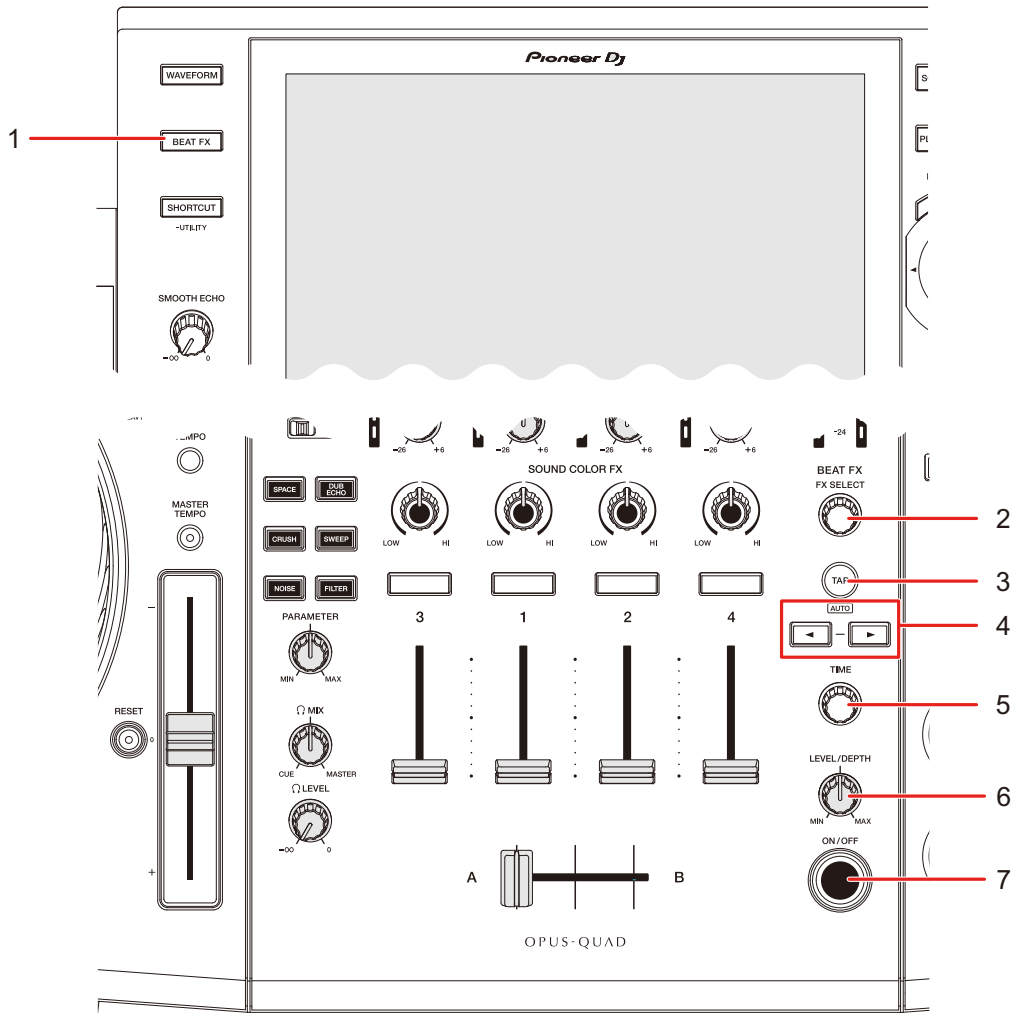

Touch screen:

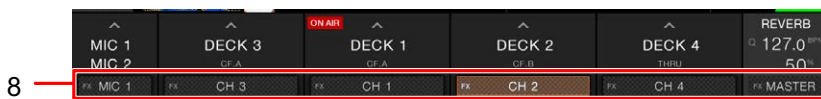

1. **BEAT FX button**
Displays the BEAT FX screen.
2. **FX SELECT knob**
Selects a Beat FX.
 - Turn to display the type of Beat FX on the main display.
3. **TAP button**
Sets BPM.
 - It's automatically set to AUTO mode when the unit is turned on.
4. **BEAT ◀, ▶ button**
Sets the number of beats for Beat FX.
5. **TIME knob**
Adjusts the time parameter for Beat FX.
6. **LEVEL/DEPTH knob**
 - Turn the knob all the way counterclockwise to output the original sound.
7. **ON/OFF button**
Turns Beat FX on and off. The button blinks when the effect is turned on.
8. **Beat FX channel selector**
Selects a channel to apply Beat FX to.

Using Beat FX

➤ Read more: Beat FX types and settings (page 111)

1 Turn the [FX SELECT] knob to select a Beat FX.

- When Beat FX are registered to Beat FX Bank, you can select a Beat FX by touching a Beat FX Bank (page 116).

2 Touch the Beat FX channel selector on the mixer information display.

3 Select a channel to apply the Beat FX to.

- To apply Beat FX to the microphone sound, touch  of MIC on the mixer information display and select a microphone from the MIC menu.

- **[MIC 1]**: Applies Beat FX to MIC 1.
- **[MIC 2]**: Applies Beat FX to MIC 2.
- **[MIC 1+MIC 2]**: Applies Beat FX to MIC 1 and MIC 2.

4 Press the [BEAT ◀] or [BEAT ▶] button to set a beat fraction to synchronize the effect with.

5 Turn the [TIME] knob and [LEVEL/DEPTH] knob to adjust the effect.

6 Press the [ON/OFF] button or touch XY-PAD to turn the Beat FX on.

The Beat FX is applied to the selected channel.

- Press the **[ON/OFF]** button again or release XY-PAD to turn the Beat FX off.
- To use the XY-PAD, press the **[BEAT FX]** button to display the Beat FX screen on the main display.

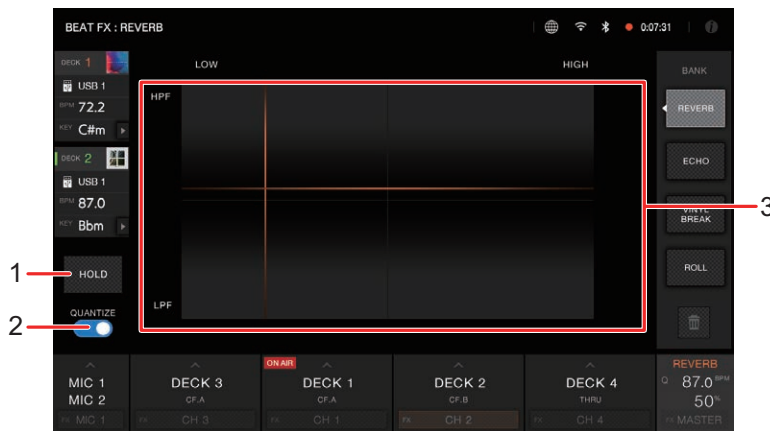

1. **HOLD**: When turned on, BEAT FX remains on even if you release the XY-PAD.
2. **QUANTIZE**: Turns on and off the Quantize function for Beat FX (page 110).
3. **XY-PAD**: Touch to turn an effect on and off. You can adjust the time and quantitative parameters when you touch or slide your finger on XY-PAD.

Setting BPM manually (Tap mode)

1 Tap the [TAP] button more than twice in time with the beat of the track.

BPM is set according to the average time between taps.

- The beat fraction is set to 1/1 when you set BPM with the [TAP] button, and the length of one beat is set as the effect time.
- Turn the [TIME] knob while pressing the [TAP] button to adjust BPM in increments of 1.
- Press the [BEAT ◀] or [BEAT ▶] button while pressing the [TAP] button to adjust BPM in increments of 0.1.
- Press the [TAP] button while pressing the [SHIFT] button to automatically set the BPM.

Using Quantize (for Beat FX)

If you use Quantize, the unit adds an effect by automatically synchronizing it with the beat according to the track's grid information analyzed by rekordbox. This happens even if you operate the [ON/OFF] button of Beat FX or XY-PAD roughly.

- Analyze the tracks in rekordbox beforehand. For details on track analysis, see the rekordbox Instruction Manual (page 8).

1 Press the [BEAT FX] button.

The BEAT FX screen appears.

2 Touch [QUANTIZE] to turn it on.

Quantize turns on.

Beat FX types and settings

You can adjust the following settings with the buttons and knobs.

Beat FX/operation	Description
DELAY ¹ ² <ul style="list-style-type: none"> • BEAT ◀, ▶: Delay time with respect to 1 beat of the BPM (beat fraction): 1/16 to 16 beats • TIME: Delay time: 1 to 4 000 (ms) • LEVEL/DEPTH: Balance between the original sound and the effected sound • XY-PAD: X: Delay time Y: High-pass filter, low-pass filter 	Outputs a delay sound once according to the beat.
ECHO ¹ ² <ul style="list-style-type: none"> • BEAT ◀, ▶: Delay time with respect to 1 beat of the BPM (beat fraction): 1/16 to 16 beats • TIME: Delay time: 1 to 4 000 (ms) • LEVEL/DEPTH: Balance between the original sound and the effected sound • XY-PAD: X: Delay time Y: High-pass filter, low-pass filter 	Outputs a delay sound several times while attenuating it according to the beat.
PING PONG ¹ ² <ul style="list-style-type: none"> • BEAT ◀, ▶: Delay time with respect to 1 beat of the BPM (beat fraction): 1/16 to 16 beats • TIME: Delay time: 10 to 4 000 (ms) • LEVEL/DEPTH: Balance between the original sound and the effected sound 	Outputs a delay sound with different delay times for the left and right several times while attenuating it according to the beat, producing a stereo-like effect.

Beat FX/operation	Description
<ul style="list-style-type: none"> • XY-PAD: 	X: Delay time Y: High-pass filter, low-pass filter
SPIRAL 1 2	Adds reverberation to the input sound.
<ul style="list-style-type: none"> • BEAT ◀, ▶: 	Delay time with respect to 1 beat of the BPM (beat fraction): 1/16 to 16 beats
<ul style="list-style-type: none"> • TIME: 	Delay time: 10 to 4 000 (ms)
<ul style="list-style-type: none"> • LEVEL/DEPTH: 	Balance between the original sound and the effected sound, and feedback
<ul style="list-style-type: none"> • XY-PAD: 	X: Delay time Y: High-pass filter, low-pass filter
REVERB 1 2	Adds reverberation to the input sound.
<ul style="list-style-type: none"> • BEAT ◀, ▶: 	Reverberation level: 1 to 100%
<ul style="list-style-type: none"> • TIME: 	Reverberation level: 1 to 100%
<ul style="list-style-type: none"> • LEVEL/DEPTH: 	Balance between the original sound and the effected sound
<ul style="list-style-type: none"> • XY-PAD: 	X: Cut-off frequency for filter Y: High-pass filter, low-pass filter
TRANS	Cyclically cuts the sound according to the beat.
<ul style="list-style-type: none"> • BEAT ◀, ▶: 	Cycle of the cut with respect to 1 beat of the BPM (beat fraction): 1/16 to 16 beats
<ul style="list-style-type: none"> • TIME: 	Effect time: 10 to 16 000 (ms)
<ul style="list-style-type: none"> • LEVEL/DEPTH: 	Balance between the original sound and the effected sound, and duty
<ul style="list-style-type: none"> • XY-PAD: 	X: Cycle of the cut Y: High-pass filter, low-pass filter

Beat FX/operation	Description
FILTER	Cyclically changes the cut-off frequency according to the beat.
<ul style="list-style-type: none"> • BEAT ◀, ▶: Moving cycle of the effect with respect to 1 beat of the BPM (beat fraction): 1/16 to 64 beats • TIME: Moving cycle of the effect: 10 to 32 000 (ms) • LEVEL/DEPTH: Effect level • XY-PAD: X: Cycle to finely fluctuate the effect Y: High-pass filter, low-pass filter 	
FLANGER	Adds a cyclic flanger effect according to the beat.
<ul style="list-style-type: none"> • BEAT ◀, ▶: Moving cycle of the effect with respect to 1 beat of the BPM (beat fraction): 1/16 to 64 beats • TIME: Moving cycle of the effect: 10 to 32 000 (ms) • LEVEL/DEPTH: Effect level • XY-PAD: X: Cycle to finely fluctuate the effect Y: High-pass filter, low-pass filter 	
PHASER	Adds a cyclic phaser effect according to the beat.
<ul style="list-style-type: none"> • BEAT ◀, ▶: Moving cycle of the effect with respect to 1 beat of the BPM (beat fraction): 1/16 to 64 beats • TIME: Moving cycle of the effect: 10 to 32 000 (ms) • LEVEL/DEPTH: Effect level • XY-PAD: X: Cycle to finely fluctuate the effect Y: High-pass filter, low-pass filter 	

Beat FX/operation	Description
PITCH	Changes the pitch of the original sound.
<ul style="list-style-type: none"> • BEAT ◀, ▶: • TIME: • LEVEL/DEPTH: • XY-PAD: 	<ul style="list-style-type: none"> Pitch of the effect sound: -50 to 100 Pitch of the effect sound: -50 to 100 Pitch of the effect sound X: Pitch of the effect sound Y: High-pass filter, low-pass filter
SLIP ROLL	<p>Records the input sound when the effect is turned on, and outputs the recorded sound repeatedly according to the specified beat fraction.</p> <p>If the effect time is changed, the input sound is recorded again.</p>
<ul style="list-style-type: none"> • BEAT ◀, ▶: • TIME: • LEVEL/DEPTH: • XY-PAD: 	<ul style="list-style-type: none"> Effect time with respect to 1 beat of the BPM (beat fraction): 1/16 to 16 beats Effect time: 10 to 4 000 (ms) Balance between the original sound and the effected sound X: Effect time Y: High-pass filter, low-pass filter
ROLL	Records the input sound when the effect is turned on, and outputs the recorded sound repeatedly according to the specified beat fraction.
<ul style="list-style-type: none"> • BEAT ◀, ▶: • TIME: • LEVEL/DEPTH: • XY-PAD: 	<ul style="list-style-type: none"> Effect time with respect to 1 beat of the BPM (beat fraction): 1/16 to 16 beats Effect time: 10 to 4 000 (ms) Balance between the original sound and the effected sound X: Effect time Y: High-pass filter, low-pass filter

Beat FX/operation	Description
VINYL BRAKE	Gradually slows down the playback speed of the input sound according to the beat and then stops playback.
<ul style="list-style-type: none"> • BEAT ◀, ▶: • TIME: • LEVEL/DEPTH: • XY-PAD: 	<p>Cycle of the effect with respect to 1 beat of the BPM (beat fraction): 1/16 to 16 beats</p> <p>Effect time: 10 to 4 000 (ms)</p> <p>Playback speed</p> <p>X: Effect time Y: High-pass filter, low-pass filter</p>
HELIX	Records the input sound and outputs the recorded sound repeatedly according to the specified time parameter.
<ul style="list-style-type: none"> • BEAT ◀, ▶: • TIME: • LEVEL/DEPTH: • XY-PAD: 	<p>Effect time with respect to 1 beat of the BPM (beat fraction): 1/16 to 16 beats</p> <p>Effect time: 10 to 4 000 (ms)</p> <p>Ratio of sound overlay</p> <ul style="list-style-type: none"> • You can change the attenuation rate by turning the [LEVEL/DEPTH] knob all the way counterclockwise and then clockwise. Turn the knob all the way clockwise to fix the output sound. <p>X: Effect time Y: High-pass filter, low-pass filter</p>

¹ When the Beat FX channel selector is set to a channel from CH 1 to CH 4, you can't monitor the effected sound even if you press the **[CUE]** button for the relevant channel.

² Only the effect sound remains if you set the channel fader to the **[0]** position to cut the input sound (the effect sound remains even after the effect is turned off).

Registering Beat FX to Beat FX Bank

You can register up to 4 Beat FX to Beat FX Bank. The registration is saved even if the unit is turned off.

- 1 Press the [BEAT FX] button.
- 2 Turn the [FX SELECT] knob to select a Beat FX to register to Beat FX Bank.

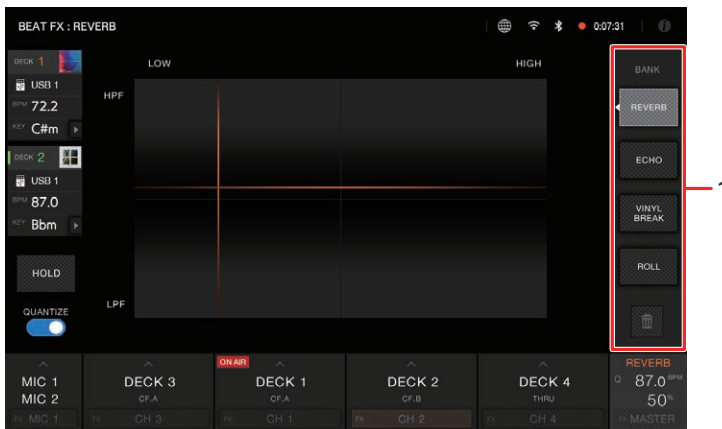

1. Beat FX Bank

3 Touch a Beat FX Bank with no Beat FX registered.

The Beat FX selected with the [FX SELECT] knob is registered to the Beat FX Bank.

- You can't register a Beat FX to any Beat FX Banks that have one registered already. Touch  to cancel the registration, and then register a Beat FX to the bank.

Smooth Echo

You can easily apply an echo to the sound being played using Smooth Echo.

Smooth Echo section

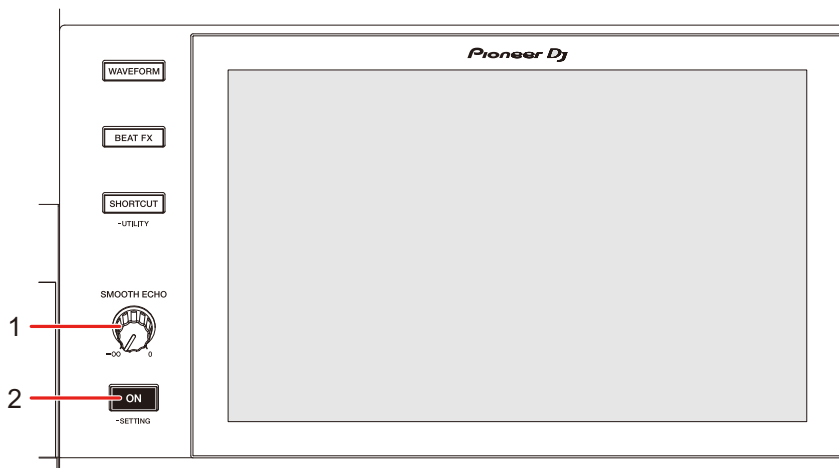

1. **SMOOTH ECHO knob**
Adjusts the volume of Smooth Echo.
2. **SMOOTH ECHO ON button**
Turns on and off Smooth Echo.

Using Smooth Echo

1 Press and hold the [SMOOTH ECHO ON] button (more than 1 second).

The settings screen appears.

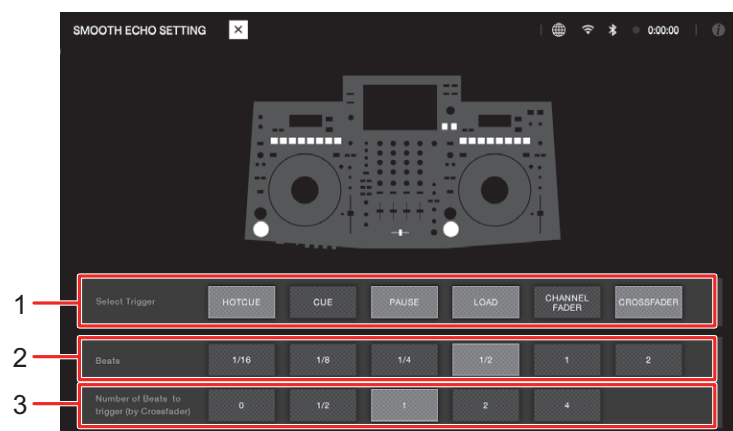

1. **Select Trigger**
2. **Beats**
3. **Number of Beats to trigger (by Crossfader)**

2 Select a trigger (operation) for the echo effect.

- **[HOT CUE]**: Applies the echo if a Hot Cue is triggered.
- **[CUE]**: Applies the echo if a Back Cue is triggered.
- **[PAUSE]**: Applies the echo if pause is triggered.
- **[LOAD]**: Applies the echo if a track is loaded.
- **[CHANNEL FADER]**: Applies the echo when the sound is muted by the channel fader.
- **[CROSSFADER]**: Applies the echo when the crossfader is moved to the opposite side and the sound is muted.

3 Set the parameters.

- **[Beats]**: Sets the number of beats for the echo.

- **[Number of Beats to trigger (by Crossfader)]**: Sets the number of beats before the echo is applied.

4 Press the [SMOOTH ECHO ON] button to turn on Smooth Echo.

The button lights up when Smooth Echo is turned on.

5 Perform the trigger operation to apply the echo.

A delay sound is output several times while attenuating according to the number of beats.

Using DJ software

If you connect a PC/Mac with MIDI software installed, to the unit via a USB cable, you can control the DJ software via the unit.

- To play tracks stored on a PC with the unit, install the dedicated audio driver software. If you use a Mac, you don't have to install the dedicated audio driver software (page 14).
- For details on the unit's MIDI messages, visit the URL below.

pioneerdj.com/support/

- Install DJ software and configure the audio and MIDI settings on a PC/Mac beforehand.
- You don't need to make MIDI settings when you use rekordbox or Serato DJ Pro with the unit.
- It's recommended to connect this unit and a PC/Mac directly with a USB cable. When using a USB hub, use a product recommended by the manufacturer of your PC/Mac. We don't guarantee the operation of all USB hubs.

Controlling DJ software

1 Connect a PC/Mac to the unit.

➡ Read more: Rear panel (page 29)

2 Press the [SOURCE] button.

The [SOURCE] screen appears.

3 Select [SOFTWARE CONTROL].

The [SOFTWARE CONTROL] screen appears.

4 Press the [LOAD 1/3] or [LOAD 2/4] button.

The deck on which you press the button switches to control mode.

5 Launch the DJ software.

The unit starts communication with the DJ software.

Using DJ software

- Some buttons on the unit can't be used for controlling a DJ application.
- Control mode turns off when a track is loaded to the unit from a device other than the currently communicating device that's running the DJ software.

Settings

You can change the settings of the unit from the Utility menu or on the [SHORTCUT] screen. If you save My Settings (function settings of the unit) to a storage device (USB), you can load them to the unit immediately when you arrive in the booth or take over from another DJ, etc.

Changing the settings

1 Press and hold the [SHORTCUT] button.

The [UTILITY] screen appears.

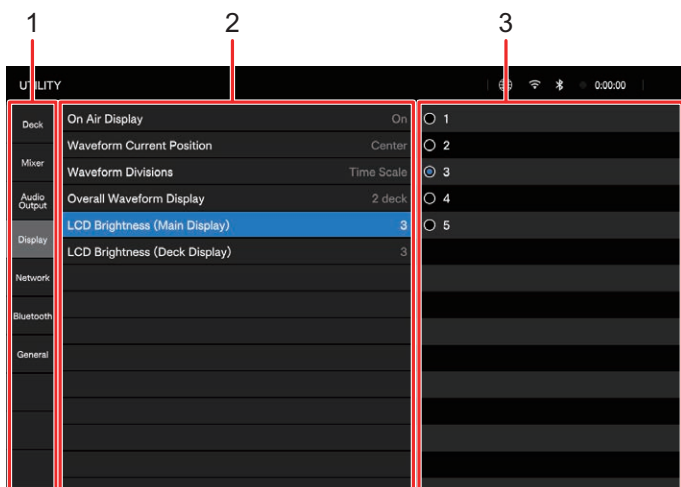

1. **Category**
2. **Setting items and current setting values**
3. **Setting values**

2 Select a category.

3 Select a setting item.

➤ Read more: Utility settings (page 123)

4 Select a setting value.

- Press the [SHORTCUT] button to close the [UTILITY] screen.

Utility settings

❖ Deck category

*: Factory setting

Setting item	Description
Load Lock	<p>Determines whether or not you can load another track during playback.</p> <ul style="list-style-type: none"> Setting values: Unlock*, Lock
Quantize Beat Value (Deck) ¹	<p>Sets the number of beats for Quantize.</p> <ul style="list-style-type: none"> Setting values: 1/8, 1/4, 1/2, 1*
Hot Cue Auto Load ¹	<p>Determines whether or not Hot Cues/Loops are automatically called up when you load a track (page 81).</p> <ul style="list-style-type: none"> Setting values: Off, rekordbox Setting, On*
Hot Cue Color	<p>Turns on and off the lighting color setting for the [HOT CUE] (A to H) buttons (page 80).</p> <ul style="list-style-type: none"> Setting values: Off*, On
Overwrite Current Cue with Hot Cue	<p>Determines whether or not a cue point is automatically set when a Hot Cue/Loop is set or playback starts from a Hot Cue/Loop (pages 80, 81).</p> <ul style="list-style-type: none"> Setting values: Off*, On
Auto Cue Level	<p>Sets the sound pressure level that Auto Cue recognizes as silence.</p> <ul style="list-style-type: none"> Setting values: -78dB, -72dB, -66dB, -60dB, -54dB, -48dB, -42dB, -36dB, Memory Cue*, Hot Cue [Memory Cue] sets the saved cue/loop point closest to the beginning of a track to an Auto Cue point. [A.CUE] lights up in white on the deck display. [Hot Cue] sets the saved Hot Cue/Loop point closest to the beginning of a track to an Auto Cue point. [A.CUE] lights up in white on the deck display.







Setting item	Description
Vinyl Speed Adjust	<p>Sets the adjustment method for the playback and stop speeds in Vinyl mode (page 70).</p> <ul style="list-style-type: none"> Setting values: Touch&Release, Touch*, Release
Play Mode	<p>Sets playback mode.</p> <ul style="list-style-type: none"> Setting values: Continue, Single* [Continue]: Automatically loads the next track when playback reaches the end of a track. [Single]: Stops playback when playback reaches the end of a track. The next track isn't automatically loaded.
Jog Ring Brightness	<p>Sets the brightness of the jog ring illumination.</p> <ul style="list-style-type: none"> Setting values: Off, 1, 2*
Jog Ring Indicator	<p>Determines whether or not to blink the jog ring illumination when playback reaches the end of a track.</p> <ul style="list-style-type: none"> Setting values: Off, On*

¹ The settings can be set on the [**SHORTCUT**] screen.

❖ Mixer category

*: Factory setting

Setting item	Description
Channel Input Select Memory	<p>Determines whether or not to save the input selector setting for [CH 3] or [CH 4].</p> <ul style="list-style-type: none"> Setting values: Off*, On The setting isn't saved when [Bluetooth] is selected with the input selector. Instead, deck 3 or deck 4 is selected when the unit is turned on. If the setting is saved when [PHONO] is selected, sound may be output at a high volume depending on the signal input to the unit when it is turned on. Make sure the input signal matches the settings to avoid this.

Setting item	Description
EQ/ISO ¹	<p>Sets the function (equalizer or isolator) to adjust with the EQ/ISO (HI, MID, LOW) knobs.</p> <ul style="list-style-type: none"> Setting values: EQ*, ISO
Channel Fader Curve ¹	<p>Sets the channel fader curve (page 95).</p> <ul style="list-style-type: none"> Setting values:  Curve1,  Curve2*,  Curve3
Crossfader Curve ¹	<p>Sets the crossfader curve (page 95).</p> <ul style="list-style-type: none"> Setting values:  Curve1*,  Curve2,  Curve3
Headphones Mono Split/Stereo ¹	<p>Sets the output method (mono split or stereo) for the headphones monitor sound.</p> <ul style="list-style-type: none"> Setting values: Mono Split, Stereo*
USB Output Level	<p>Sets the attenuation level of the sound output from the USB port (Type-C).</p> <ul style="list-style-type: none"> Setting values: -19dB*, -15dB, -10dB, -5dB
Mic Output to Booth	<p>Determines whether or not to output the microphone sound to the [BOOTH] terminals.</p> <ul style="list-style-type: none"> Setting values: Off, On*
Mic Output to Master REC	<p>Determines whether or not to output the microphone sound to Master Rec (recording sound).</p> <ul style="list-style-type: none"> Setting values: Off, On*
Mic Output to USB	<p>Determines whether or not to output the microphone sound to the USB port (Type-C).</p> <ul style="list-style-type: none"> Setting values: Off, On*

Setting item	Description
Talkover Mode	<p>Sets TALKOVER mode.</p> <ul style="list-style-type: none"> Setting values: Advanced*, Normal The [Advanced] setting outputs sound by attenuating only the mid-frequency range of the sound from channels other than the [MIC] channels according to the setting of the [LEVEL] knob. The [Normal] setting outputs sound by attenuating the sound from channels other than the [MIC] channels according to the [LEVEL] knob setting.
Talkover Level	<p>Sets the sound attenuation level for Talkover.</p> <ul style="list-style-type: none"> Setting values: -24dB, -18dB*, -12dB, -6dB

¹ The settings can be set on the [**SHORTCUT**] screen.

❖ Audio Output category

*: Factory setting

Setting item	Description
Master Attenuator	<p>Sets the attenuation level of the sound output from the [MASTER 1] and [MASTER 2] terminals.</p> <ul style="list-style-type: none"> Setting values: -12dB, -6dB, 0dB*
Master Peak Limiter	<p>Sets whether or not to reduce sudden and unpleasant digital clips that occur on the master output.</p> <ul style="list-style-type: none"> Setting values: Off, On*
Booth Monitor Attenuator	<p>Sets the attenuation level of the sound output from the [BOOTH] terminals.</p> <ul style="list-style-type: none"> Setting values: -12dB, -6dB, 0dB*
Zone Attenuator	<p>Sets the attenuation level of the sound output from the [ZONE] terminals.</p> <ul style="list-style-type: none"> Setting values: -12dB, -6dB, 0dB*

❖ Display category

*: Factory setting

Setting item	Description
On Air Display	<p>Determines whether or not to display On Air Display on the mixer information display.</p> <ul style="list-style-type: none"> Setting values: Off, On*
Waveform Current Position	<p>Sets where to display the current playback point (center or left) on the waveform.</p> <ul style="list-style-type: none"> Setting values: Center, Left*
Waveform Divisions	<p>Selects time scale or phrase data to display under the playing address on the main display.</p> <ul style="list-style-type: none"> Setting values: Time Scale, Phrase* [Time Scale]: Displays scale marks at 30-second intervals. [Phrase]: Displays the phrase data analyzed by rekordbox. If phrase data isn't saved, time scale is displayed.
Overall Waveform Display ¹	<p>Selects 2-deck display or 4-deck display for the main display.</p> <ul style="list-style-type: none"> Setting values: 2deck*, 4deck
LCD Brightness (Main Display) ¹	<p>Sets the brightness of the main display.</p> <ul style="list-style-type: none"> Setting values: 1, 2, 3*, 4, 5
LCD Brightness (Deck Display) ¹	<p>Sets the brightness of the deck display.</p> <ul style="list-style-type: none"> Setting values: 1, 2, 3*, 4, 5

¹ The settings can be set on the [**SHORTCUT**] screen.

❖ Network category

*: Factory setting

Setting items	Description
Wi-Fi Setting	Sets up the connection via a wireless router (access point) (page 129).
Wi-Fi Frequency	Set the frequency band to be used. <ul style="list-style-type: none"> Setting values: 5GHz (Recommended)*, 2.4GHz/5GHz
Wi-Fi Address	Displays IP address and MAC address for the wireless LAN connection.
Ethernet Info	Displays IP address and MAC address for the wired LAN connection.

❖ Bluetooth category

Setting items	Description
Bluetooth Setting	Sets up the connection via Bluetooth (page 131).

❖ General category

*: Factory setting

Setting item	Description
Language	Sets the display language.
Screen Saver	<p>Sets the screen saver.</p> <ul style="list-style-type: none"> Setting values: Off, On* When set to [On], the screen saver starts if: <ul style="list-style-type: none"> You don't use the unit for more than 5 minutes when a track isn't loaded. You don't use the unit for more than 100 minutes during pause, during cue standby, or after playback reaches the end of a track. Use the unit to cancel the screen saver.
Auto Standby	<p>Sets the auto standby function (page 129).</p> <ul style="list-style-type: none"> Setting values: Off, On*

Setting item	Description
Default	Restores the settings to the factory settings. <ul style="list-style-type: none"> Setting values: Cancel*, Ok
Serial No.	Displays the serial number.
License	Displays the license information of the unit.
VERSION No.	Displays the version of the software on the unit.

Auto standby

When **[Auto Standby]** is set to **[On]**, the unit enters standby mode after 4 hours without being used in the following ways.

- No audio signal is input to the unit.
- The unit isn't connected in the PRO DJ LINK network.
- No storage device (USB) is connected to the unit.
- No PC/Mac is connected to the unit via the USB port on the rear of the unit.

Press the **[QUANTIZE]** button on deck 1/3 to exit standby mode.

- The factory setting is **[On]**.
- Set **[Auto Standby]** to **[Off]** if you don't need to use the auto standby function.

Wireless LAN (Wi-Fi®) connection

Connecting the unit to a wireless network

1 Press and hold the **[SHORTCUT]** button.

The **[UTILITY]** screen appears.

2 Select **[Wi-Fi Setting]**.

The **[Wi-Fi Setting]** screen appears.

3 Touch [Wi-Fi] to turn it on.

The unit searches the network and available SSID are listed.

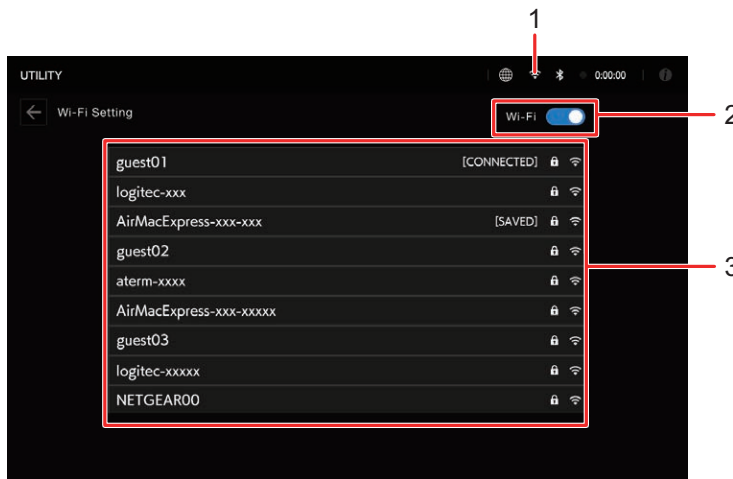

1.  (Wi-Fi connection icon)
2. **Wi-Fi On/Off**
3. **SSID list**

4 Touch the network (SSID) you want to use.

The password input screen appears.

5 Enter a password and touch [CONNECT].

If the connection succeeds, **[CONNECTED]** is displayed in the network name (SSID) field and it's displayed at the top of the list.

- You don't need to do this if you're using an access point that's connected with the unit previously.
- Touch the network (SSID) you're using to view its information on the network information screen. If you turn on **[AUTO-CONNECT]** on the network information screen, the unit automatically connects to the access point the next time you use it.
- To delete the networks (SSID) saved to the unit, touch **[SAVED NETWORKS]** at the bottom of the list. Select the networks (SSID) to delete in the list and touch **[FORGET THIS NETWORK]** on the network information screen.

Bluetooth[®]/MD connection

You can input the sound of your PC/Mac or mobile device to the unit via Bluetooth.

Pairing with a Bluetooth device

1 Press and hold the [SHORTCUT] button.



The [UTILITY] screen appears.

2 Select [Bluetooth Setting].

The [Bluetooth Setting] screen appears.

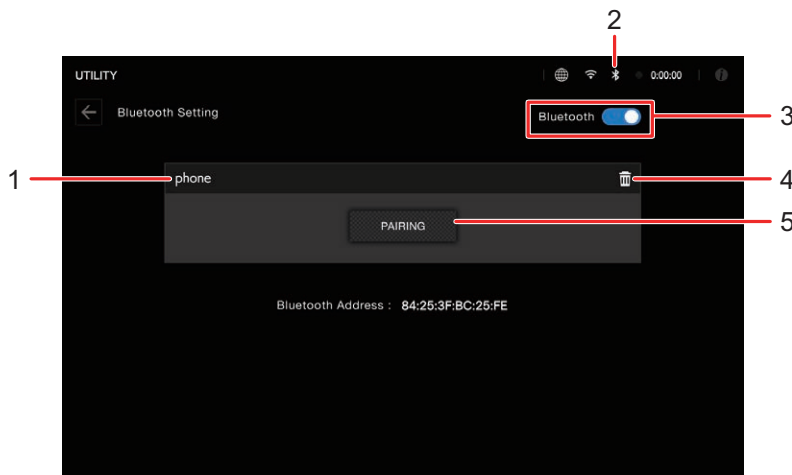
3 Touch [Bluetooth] to turn it on.



1. Name of the connected device
2.  (Bluetooth connection icon)
3. Bluetooth On/Off
4.  (Remove device)
5. PAIRING

4 Touch [PAIRING].

The unit enters pairing state.

- The Bluetooth indicator blinks while the unit is in pairing state (for approximately 2 minutes).

5 Perform the pairing procedure on a Bluetooth device.

6 Allow the connection on the unit.

The Bluetooth indicator on the unit stops blinking and lights up when the connection is established.

- Perform the pairing procedure on a Bluetooth device while the unit is in pairing state. If the unit can't pair with a Bluetooth device within 2 minutes, the Bluetooth indicator turns gray.
- For details on the pairing procedure for the Bluetooth device, refer to the device's instruction manual.
- If you use a Bluetooth device registered to the unit, the unit automatically connect the device when Bluetooth is turned on.
- You can only connect the unit to one Bluetooth device at a time. If the unit pairs with a second device, the registration of the first device will be lost. To register the first device again, perform pairing with the device.
- Touch  to connect with other Bluetooth device than the registered one.

Changing the settings on the Shortcut screen

1 Press the [SHORTCUT] button.

The [SHORTCUT] screen appears.

Deck/Display tab:

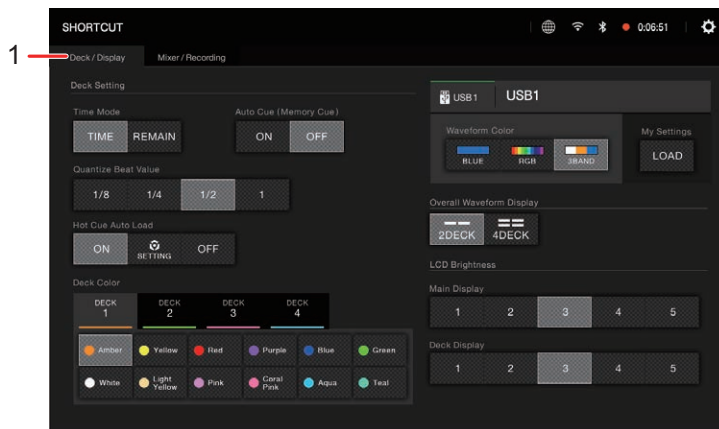

Mixer/Recording tab:

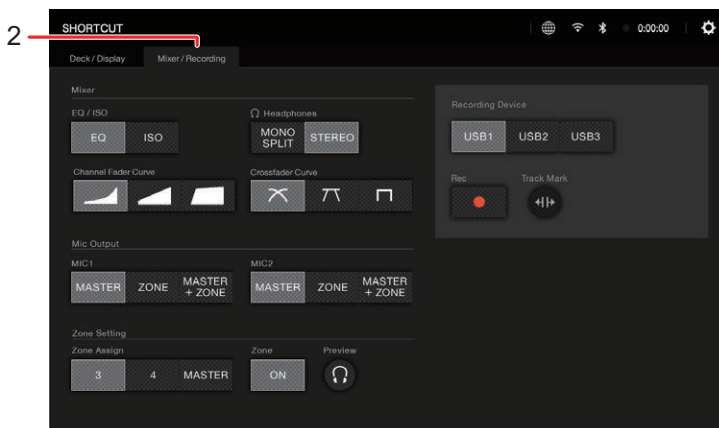

1. Deck/Display tab
2. Mixer/Recording tab

2 Select a setting value.

📖 Read more: Setting items on the Shortcut screen (page 134)

- Press the [SHORTCUT] button again to close the [SHORTCUT] screen.

Setting items on the Shortcut screen

❖ Deck/Display tab

Setting item	Description
Deck Setting	
Time Mode	Sets the time display ([TIME] (elapsed time) or [REMAIN] (remaining time)) on both decks.
Auto Cue	Turns Auto Cue on and off on both decks.
Quantize Beat Value	Same as the Utility settings (page 123)
Hot Cue Auto Load	
Deck Color	Sets the color for jog ring illumination, the deck buttons, and the [LOAD] buttons for each deck.
Device name	Displays the device name.
Waveform Color	Sets the waveform color.
My Settings	Touch [LOAD] to call up My Settings from a storage device (USB) (page 136).
Overall Waveform Display	Same as the Utility settings (page 123)
LCD Brightness	
Main Display	Same as the Utility settings (page 123)
Deck Display	

❖ Mixer/Recording tab

Setting item	Description
Mixer	
EQ/ISO	
Headphones	Same as the Utility settings (page 123)
Channel Fader Curve	
Crossfader Curve	
Mic Output	
MIC 1	Sets the output destination for the MIC 1 sound.
MIC 2	Sets the output destination for the MIC 2 sound.
Zone Setting	
Zone Assign	Sets a channel to output to the [ZONE] terminals.
Zone	Turns the ZONE output on and off.
Preview	You can monitor the sound of ZONE while touching [Preview] (page 96).
Recording	
Recording Device	Sets a recording device (page 68).
Rec	Starts recording (page 68).
Track Mark	Split a track while recording (page 68).

Calling up My Settings saved on a storage device (USB)

You can call up My Settings from a storage device (USB).

- You can call up My Settings from rekordbox connected in the PRO DJ LINK network or CloudDirectPlay.

1 Connect a storage device (USB) to the unit.

➡ Read more: Connecting storage devices (USB) (page 46)

2 Press the [SOURCE] button.

The [SOURCE] screen appears.

3 Select a device.

4 Press the [SHORTCUT] button.

The [SHORTCUT] screen appears.

5 Touch [LOAD] in [MY SETTINGS].

My Settings are called up.

- You can't call up My Settings when a track is playing. Pause the playback before calling up the settings.
- Press the [SHORTCUT] button again to close the [SHORTCUT] screen.

Specifications

General

Power requirements.....	AC 110 V – 240 V, 50 Hz / 60 Hz
Power consumption	60 W
Power consumption (standby)	0.3 W
Main unit weight.....	13.2 kg / 29.1 lbs.
Max. external dimensions (W × D × H)	925.7 × 499.7 × 142 mm / 36.44" x 19.67" x 5.59"
Tolerable operating temperature	+5 °C – +35 °C (+41 °F – +95 °F)
Tolerable operating humidity	5 % – 85 % (no condensation)

Audio Section

Sampling rate.....	44.1 kHz
MASTER D/A converter	32bit
Other A/D and D/A converters.....	24bit
Frequency characteristic	
USB, LINE, MIC 1, MIC 2.....	20 Hz – 20 kHz
S / N ratio (rated output, A-WEIGHTED)	
USB.....	114 dB
LINE	96 dB
PHONO	85 dB
MIC.....	79 dB
Total harmonic distortion (20 Hz – 20 kHz BW)	
USB.....	0.003 %
LINE	0.005 %
Standard input level / Input impedance	
LINE	-12 dBu / 47 kΩ
PHONO	-52 dBu / 47 kΩ
MIC.....	-57 dBu / 3 kΩ
Standard output level / Load impedance / Output impedance	
MASTER 1	+6 dBu / 10 kΩ / 360 Ω or less
MASTER 2	+2 dBu / 10 kΩ / 700 Ω or less
ZONE	+6 dBu / 10 kΩ / 360 Ω or less
BOOTH	+6 dBu / 10 kΩ / 700 Ω or less
PHONES.....	+8 dBu / 32 Ω / 1 Ω or less
Rated output level / Load impedance	
MASTER 1	+25 dBu / 10 kΩ

Specifications

MASTER 2	+21 dBu / 10 kΩ
Crosstalk	
LINE	84 dB
Channel equalizer characteristic	
HI.....	-26 dB – +6 dB (20 kHz)
MID.....	-26 dB – +6 dB (1 kHz)
LOW	-26 dB – +6 dB (20 Hz)
Microphone equalizer characteristic	
HI.....	-12 dB – +12 dB (10 kHz)
MID.....	-12 dB – +12 dB (2.5 kHz)
LOW	-12 dB – +12 dB (100 Hz)

Input / Output terminals

LINE / PHONO input terminals

RCA pin jacks 2 sets

MIC input terminals

XLR connector & 1/4" TRS jack 2 sets

MASTER 1 output terminal

XLR connector 1 set

MASTER 2 output terminal

RCA pin jacks..... 1 set

ZONE output terminal

XLR connector 1 set

BOOTH output terminal

1/4" TRS jack 1 set

PHONES output terminal

1/4" stereo jack..... 1 set

3.5 mm stereo mini jack 1 set

USB terminals

USB Type-A..... 3 sets

Power supply.....5 V / 1 A or less

USB Type-C 1 set

LINK terminal (PRO DJ LINK)

LAN terminal (1000BASE-T) 1 set

Wireless LAN section

Supported standards..... IEEE 802.11 a / b / g / n / ac

Frequency band used 2.4 GHz / 5 GHz

Bluetooth section

Wireless system.....	Bluetooth ver. 4.2
Maximum transmission distance.....	Approximately 20 m* in unobstructed circumstances.
Frequency band used	2.4 GHz
Modulation method	FH-SS (Frequency Hopping Spread Spectrum)
Compatible codecs	SBC, AAC

* Transmission distances are a guideline. Transmission distance may change depending on the surrounding environment.

We don't guarantee that this unit will connect and operate with all wireless LAN routers and Bluetooth devices.

The specifications and design of this product are subject to change without notice.

Additional information

Troubleshooting

If you think something is wrong with the unit, check the information below and refer to the [FAQ] for the OPUS-QUAD at the URL below.

pioneerdj.com/support/

- Inspect devices connected with the unit.
- The unit may restore proper operation after you turn it off and on.

If the problems continue, read the “Precautions for Use” and consult an authorized service company or your dealer.

Error display

❖ E-8302 (Error type: CANNOT PLAY TRACK)

- The unit can't read audio files from the storage device. The audio files may be corrupted. Check if the files can be played with another player that supports files in the formats supported by this unit.

❖ E-8304/E-8305 (Error type: UNSUPPORTED FILE FORMAT)

- The loaded audio file is in a format that isn't supported by this unit. Play an audio file in a format that's supported by this unit (page 10).

Wireless LAN (Wi-Fi)

❖ The unit can't connect to an access point.

- Check if the network (SSID), password, and security type are set correctly. Match the settings on this unit with the network settings.

❖ The access point can't be found.

- If the unit and the wireless router are placed far apart, bring them closer together.
- If there is an obstacle between this unit and the wireless router, remove it.

Bluetooth

❖ The unit can't connect with a Bluetooth device.

- Turn on the unit and the Bluetooth device again, and perform the pairing procedure.

❖ Sound is interrupted.

- If the unit and the Bluetooth device is placed far apart, bring them closer together.
- If there is an obstacle between this unit and the Bluetooth device, remove it.
- Signal interference may occur when using Bluetooth and wireless LAN (Wi-Fi) at the same time. Turn wireless LAN (Wi-Fi) off or set **[Wi-Fi Frequency]** in the UTILITY settings to **[5GHz (Recommended)]**.

CloudDirectPlay

❖ Tracks aren't displayed or can't be loaded.

- Tracks aren't displayed on the browse screen if rekordbox for Mac/Windows or rekordbox for iOS/Android and the library in the cloud haven't been synchronized. Use the unit after the synchronization completes.
- Tracks aren't uploaded to Dropbox.
Only tracks uploaded to Dropbox are displayed on the browse screen. If the upload hasn't completed, you can't load the tracks. Upload the tracks you want to use to Dropbox beforehand using rekordbox for Mac/Windows or rekordbox for iOS/Android.
- You can't load tracks to the unit when Dropbox is under maintenance or failure occurs in Dropbox. Use after the maintenance completes or after the issue is fixed. You can check the maintenance and failure status at the Dropbox website below.

<https://status.dropbox.com/>

❖ The capacity of the USB device is insufficient.

- When using CloudDirectPlay, tracks loaded from Dropbox are temporarily saved on a USB device. Sufficient free space is required for saving the loaded tracks on the USB device. The reference file size for a track is as follows (it depends on the length of the track and the file format).
 - mp3 format: 12 MB (for a 6-minute track with 320 kbps)
 - WAV format: 66 MB (for a 6-minute track with CD sound quality)

LCD display

- Small black or shining points may appear on the LCD display. This is a phenomenon inherent to LCD displays and not a malfunction.
- When using the unit in cold places, the LCD display may be dark for a while after the power is turned on. Normal brightness will restore after a while.
- When the LCD display is exposed to direct sunlight, the light will reflect off it, making it difficult to see. Block the direct sunlight to improve visibility of the display.

Cleaning

Wipe with a dry soft cloth.

- Do not use organic solvents, acids or alkalis for cleaning.

Touch screen

- Operate the touch screen with your fingertip. Do not press it with excessive force.
- Do not operate the touch screen with hard and sharp-pointed objects such as a ballpoint pen, mechanical pencil, or sharp fingernail.

Trademarks and registered trademarks

- rekordbox™ is a trademark or registered trademark of AlphaTheta Corporation.
- PRO DJ LINK™ is a trademark or registered trademark of AlphaTheta Corporation.
- Mac, macOS and Finder are trademarks of Apple Inc., registered in the U.S. and other countries.
- Windows is a registered trademark of Microsoft Corporation in the U.S. and other countries.
- ASIO is a trademark or registered trademark of Steinberg Media Technologies GmbH.
- Serato DJ Pro is a registered trademark of Serato Limited.
- iOS is a trademark containing Cisco trademark signs in the U.S. and other countries.
- Android is a trademark of Google LLC.
- Dropbox is a trademark or registered trademark of Dropbox, Inc.
- Wi-Fi is a registered trademark of Wi-Fi Alliance®.
- The Bluetooth®/MD word mark and logos are registered trademarks owned by Bluetooth SIG, Inc. and any use of such marks by AlphaTheta Corporation is under license. Other trademarks and trade names are those of their respective owners.

Other product, technology and company names, etc. mentioned herein are trademarks or registered trademarks of their respective owners.

About using MP3 files

This product has been licensed for nonprofit use. This product has not been licensed for commercial purposes (for profit-making use), such as broadcasting (terrestrial, satellite, cable or other types of broadcasting), streaming on the Internet, Intranet (a corporate network) or other types of networks or distributing of electronic information (online digital music distribution service). You need to acquire the corresponding licenses for such uses. For details, see <http://www.mp3licensing.com>.

Cautions on copyrights

rekordbox restricts playback and duplication of copyright-protected music contents.

- When coded data, etc., for protecting the copyright is embedded in the music contents, it may not be possible to operate the program normally.
- When rekordbox detects that coded data, etc., for protecting the copyright is embedded in the music contents, processing (playback, reading, etc.) may stop.

Recordings you have made are for your personal enjoyment and according to copyright laws may not be used without the consent of the copyright holder.

- Music recorded from CDs, etc., is protected by the copyright laws of individual countries and by international treaties. It is the full responsibility of the person who has recorded the music to ensure that it is used legally.
- When handling music downloaded from the Internet, etc., it is the full responsibility of the person who has downloaded the music to ensure that it is used in accordance with the contract concluded with the download site.

The specifications and design of this product are subject to change without notice.

© 2022 AlphaTheta Corporation. All rights reserved.

<DRI1795-B>